

STERNKREUZ



F 18

Kleinuhrformgläser







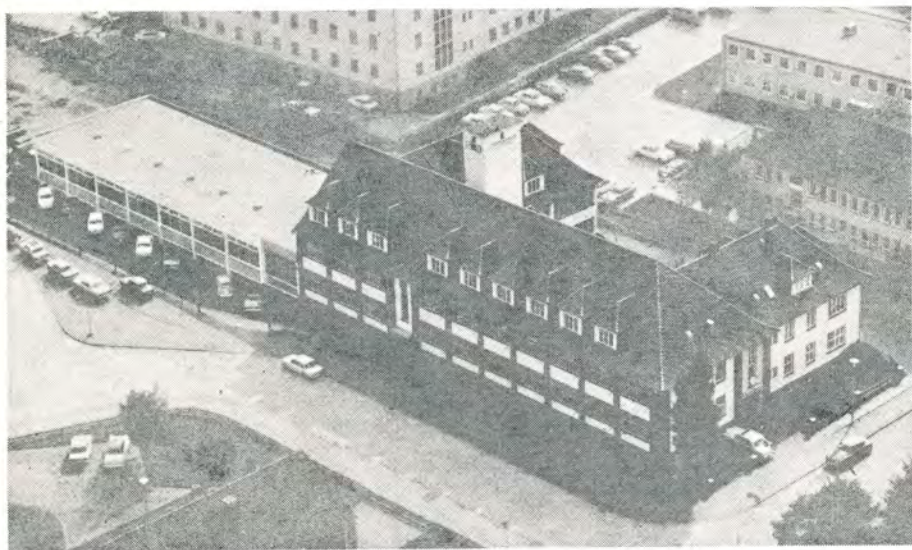



Fancy glasses
Glaces de forme
Cristales de forma
Systemet för formglas

S+K
STERNKREUZ



Inhaltsverzeichnis - Index - Table de Matieres Indice - Innehallsförteckning

Seite, Page, Pages, Pagina, Sida

Radiustabelle	5
Das STERNKREUZ-System	6
STERNKREUZ-Formgläser - Fancy glasses - pour verres de forme para cristales de forma - formglas	
R Tabelle	8
R 	29
T Tabelle	38
T 	47
B Tabelle	52
B 	60
L 	81
E 	89
D 	105
H 	109
G 	111
Spezial	115
STERNKREUZ Formdichtungen Fancy gaskets Bagues d'étanchéité de forme Anillo de junta de forma Formtättningsringar	
	133
Das Einsetzen von Formgläsern Fitting Shaped glasses La pose des verres de forme Colocar de cristales de forma Insättning av formglas	
	144
STERNKREUZ Verglasungsdienst Glass fitting service Service de poses de verres Servicio del aprovisionamiento con cristales Förglasningstjänst	
	150
STERNKREUZ Aufbauschränke propose-built cabinets for the storage of watch glasses Armoire de rangement STERNKREUZ pour le stockage exact de verres STERNKREUZ - muebles para el almacenaje apropiado de cristales de reloj STERNKREUZ Glaskap	
	152

Um der Vielfalt der heutigen Uhrglas-
Formen gerecht zu werden, hält
STERNKREUZ das größte, zeitgemäße
Sortiment in der Welt an Gläsern
bereit. Zur Bestimmung des jeweils
erforderlichen Glases geben wir Ihnen
als versiertem Fachmann mit diesem
Katalog die notwendigen Unterlagen
anhand, um Ihnen die fachgerechte
Arbeit zu Ihrem Nutzen zu erleichtern.

STERNKREUZ-Uhrgläser — die
Vollendung der Uhr!

In diesem Katalog finden Sie alle
lieferbaren STERNKREUZ-Formgläser
nach dem Stand vom März 1977.

STERNKREUZ-Formgläser werden
geordnet nach dem Form—Maß—
Farbsystem. Das Einordnen nach
Formen und Maßen erlaubt den Aufbau
eines geordneten Gläserlagers. Somit
kann der Fachmann das passende
Glas für jedes Gehäuse und für jede
Uhr finden.

Das Form—Maß—Farbsystem ist in
seinem Aufbau auf den folgenden
Seiten übersichtlich erläutert. Bitte
lesen Sie diese Übersicht, dann werden
auch Sie sehr schnell sagen:
STERNKREUZ — das Glas für jede Uhr.

To meet the present wide variety of
watch glass shapes STERNKREUZ
provide the world's largest assortment
of modern glasses. This catalogue
contains all the information an expert
needs to help him identify a particular
glass.

STERNKREUZ watch glass give
distinction to your watch!
In this catalogue you will find all the
STERNKREUZ Fancy Glasses
available in March, 1977.

Each STERNKREUZ Fancy Glass is
classified according to our system of
shapes, measures and colours which
makes possible the construction of
a well organized stock of glasses.
This way the expert can easily find
the right glass for every watch.

The structure of this system is
explained in detail on the following
pages. Please study it carefully, and
you, too, will say: STERNKREUZ
glasses for every watch.

Pour satisfaire à de multiples formes de verres de montres, STERNKREUZ dispose du plus grand assortiment conforme du monde. Pour déterminer le verre nécessaire nous vous soumettons, à vous homme de métier, ce catalogue avec tous les détails qui aideront et faciliteront votre travail compétent.

Les verres de montres STERNKREUZ: l'habillage parfait de la montre! Dans ce catalogue vous trouvez tous les verres de forme STERNKREUZ livrables à partir de mars 1977.

Les verres de forme STERNKREUZ sont classés selon le système: formes — dimensions — couleurs. Le classement selon formes et dimensions permet l'organisation d'un stock de verres bien ordonné. Ainsi, l'expert peut trouver facilement le verre correspondant à chaque boîte de montre. 

Un sommaire de l'organisation du système formes — dimensions — couleurs est expliqué clairement sur les pages suivantes. Veuillez lire ce sommaire et vous direz aussi très vite: STERNKREUZ — le verre pour toutes les montres!

Para satisfacer todas las variedades de las formas de cristales de reloj actuales STERNKREUZ tiene disponible el más gran surtido de cristales modernos del mundo. Para la selección del cristal resp. necesario les damos a Vds. como especialista versado las documentaciones necesarias con este catálogo, para facilitar a Vds. a su provecho el trabajo perito.

STERNKREUZ-cristales de reloj — la perfección del reloj! En este catálogo Vds. encuentran todos los cristales de forma STERNKREUZ conforme al estado de marzo 1977.

STERNKREUZ-cristales de forma son clasificados según el sistema forma—medida—color. Clasificar según formas y medidas permite una creación de un almacén de cristales clasificado. Por consiguiente el especialista puede hallar el cristal perteneciente a cada caja y a cada reloj.

El sistema forma—medida—color es explicado en su estructura claramente dispuesto a las páginas siguientes. Les rogamos a Vds. de leer esta exposición, entonces Vds. también dirán en seguida: STERNKREUZ — el cristal para cada reloj.

För att kunna täcka behovet av de modärna urens otaliga glasformer Har STERNKREUZ världens största och ständigt aktuella lager av urglas.

För beställning av formglasen får Ni som erfaren yrkesman med denna katalog ett bra hjälpmedel vilket underlättar fackmässigt arbete.

STERNKREUZ urglas — urets fulländning!

Denna katalog upptager alla formglas som STERNKREUZ kan leverera från mars 1977.

STERNKREUZ formglas är ordnade i ett Form—Mått—Färg-system vilket i hög grad underlättar upplägandet av ett välordnat glaslager. Här finner fackmannen lätt ett passande glas till varje ur och varje boett.

Form—Mått—Färg-systemet förklaras utförligt på följande sidor, studera denna översikt varefter även Ni säger: STERNKREUZ-glasen för varje ur.

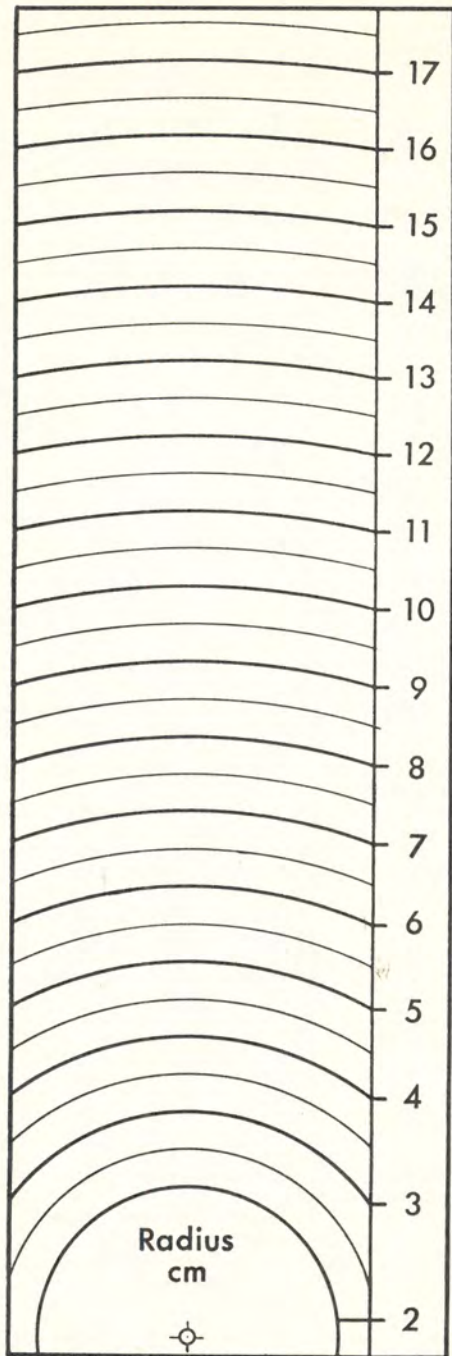

Radius-Tabelle für die Messung der Randwölbung bei Uhrgläsern mit gewölbter Auflage.

Table of radii for measuring the curvature at the edges of domed glasses.

Jauge pour apprécier Le rayon de courbure des verres bombés.

Cuadro de los radios para medir el abombamiento del borde a los cristales de reloj con soporte abombado.

Skala för mätning av glasfalsens böjningsgrad.

Radius r_w
(für RZ und RX)

Das Sternkreuz System für Formgläser

Sternkreuz classification for Fancy glasses



Le système Sternkreuz pour verres de forme

Die Sternkreuz Formgläser werden in Tüten von 40 mm Breite (Rundgläser 45 mm breit) in folgenden Farben geliefert:

- Schwarz – Standard Formgläser **1**
 - Rot – Optik Formgläser **2**
 - Grün – Konkav Formgläser **3**
 - Gelb – Spezial Formgläser **4**
- Durchsichtig – LED Formgläser

Neben der Glasgröße ist auf den Tüten die Glasform mit folgenden Großbuchstaben angegeben:

- R** = Rechteckform
- T** = Tonnenform
- B** = Ballenform
- L** = Laternenform
- E** = Ellipsenform
- D** = Dreieckform
- H** = Hufeisenform
- G** = Geigenform

Außerdem ist die eventuelle Wölbung der Glasaufschlagfläche angegeben mit den Zusatzbuchstaben:

- Z** = für einseitig gebogenen Glasrand
- X** = für allseitig gebogenen Glasrand

Abweichungen in der Form sind schließlich mit folgenden

Kleinbuchstaben gekennzeichnet:

- r** = nach außen runde Ecken
- s** = schräge Ecken
- g** = gerade Flanken
- i** = nach innen runde Ecken
- e** = gleichschenkliges Sechseck
- a** = gleichseitiges Achteck
- y** = asymmetrisch

Bei Bestellungen geben Sie bitte an:

1. Die Anzahl der gewünschten Gläser
2. Die Glassorte
3. Die Kennbuchstaben
4. Die Glasgröße

Sternkreuz Fancy watch-glasses are supplied in standard sized bags of 40 mm width (round glasses 45 mm) with the following colours:

- Black – Standard shape **1**
 - Red – Optic shape **2**
 - Green – Concave shape **3**
 - Yellow – Special shape **4**
- Transparent – LED shape

Apart from the size of the glass on the bags the shape is specified with the following capital letters:

- R** = Rectangular shape
- T** = Barrel shape
- B** = Bale shape
- L** = Lantern shape
- E** = Elliptic shape
- D** = Triangular shape
- H** = Horseshoe shape
- G** = Violin shape

Moreover, the eventual curvature of the glass is specified with additional letters:

- Z** = for one side domed bezel
- X** = for all sides domed bezel

Variations in the shape are specified finally with the following small letters:

- r** = round corners
- s** = straight-cut corners
- g** = straight flanks
- i** = convex corners
- e** = isocetes hexagon
- a** = equilateral octagon
- y** = asymmetrical

When ordering, please specify:

1. Quantity of watch-glasses required
2. The type
3. Identification letter
4. Glass dimensions

Les verres de forme Sternkreuz sont livrés en sachets de 40 mm de largeur (verres ronds 45 mm de largeur) dans les couleurs suivantes:

- Noir – verres de forme standard **1**
 - Rouge – verres de forme optiques **2**
 - Vert – verres de forme concaves **3**
 - Jaune – verres de forme spéciaux **4**
- Transparent – verres de forme LED

A côté de la taille des verres est indiquée, sur les sachets, la forme de verre au moyen des lettres suivantes:

- R** = Rectangulaire
- T** = Tonneau
- B** = Balle
- L** = Lanterne
- E** = Ellipse
- D** = Triangulaire
- H** = Fer à cheval
- G** = Violon

En outre, la cambrure éventuelle de la surface d'appui du verre est indiquée par les lettres supplémentaires:

- Z** = pour bord de verre bombé d'un côté
- X** = pour bord de verre bombé tous côtés

Des modifications dans la forme, enfin, caractérisées par les lettres minuscules suivantes:

- r** = coins arrondis vers l'extérieur,
- s** = coins en biais,
- g** = flancs droits,
- i** = coins arrondis vers l'intérieur
- e** = coin hexagonal isocèle
- a** = coin octogonal isocèle
- y** = asymétrique

Lors de la passation de commande, il y a lieu d'indiquer:

1. La quantité de verres désirée
2. Le genre de verres
3. Les lettres caractéristiques
4. La taille des verres.

La clasificación Sternkreuz para cristales de forma

Sternkreuz system för formglas



Los cristales de forma Sternkreuz se suministran en bolsitas de 40 mm. de ancho (cristales redondos 45 mm. de ancho), en los colores siguientes:

- Negro - Cristal en forma standard 1
- Rojo - Cristal en forma óptica 2
- Amarillo - Cristal en forma cóncava 3
- Verde - Cristal en forma especial 4
- Transparente - Cristal en forma LED

Sobre las bolsitas, junto a la medida del cristal, se indica la forma del cristal con letras grandes como sigue:

- R = Rectangular
- T = Barril
- B = Fardo
- L = linterna
- E = Elíptica
- D = Triangular
- H = Herradura
- G = Violin

Además, se indica la eventual curvatura del cristal con letras adicionales como:

- Z = Borde de cristal curvado por un lado
- X = Borde de cristal curvado por todos lados

Finalmente, las variaciones en la forma están indicadas con las siguientes letras minúsculas:

- r = Angulos redondos hacia fuera
- s = Angulos inclinados
- g = Flancos rectos
- i = Angulos redondos hacia adentro
- e = Hexágono equilátero
- a = Octágono equilátero
- y = Asimétrico

En los pedidos rogamos indiquen ustedes:

1. Cantidad de cristales que se piden
2. Clase de cristal
3. Letras de identificación
4. Medida del cristal

Sternkreuz formglas leveras i 40 mm breda påsar (rundglas i 45 mm breda påsar) i följande färger:

- Svart - Standard formglas 1
- Röd - Optik formglas 2
- Grön - Konkav formglas 3
- Gul - Special formglas 4
- Genomskinlig - LED formglas

Förutom glasets mått anges på påsen glasets form med någon av följande stora bokstäver:

- R = Rektangulär form
- T = Tunnform
- B = Balform
- L = Lyktform
- E = Ellipsform
- D = Trekantform
- H = Hästskoform
- G = Fiolform

Dessutom anges glasets eventuella vällvning med tilläggsbokstaven:

- Z = Ensidigt vällvd glassarg
 - X = Allsidigt vällvd glassarg
- Eventuella avvikelser i formen anges slutligen med någon av följande små bokstäver:

- r = Avrundade hörn
- s = Avskurna hörn
- g = Raka sidor
- i = Insvängda hörn
- e = Liksidigt sexhörnigt
- a = Liksidigt åttahörnigt
- y = Assymetriskt

Vänligen angiv vid beställning:

1. Önskat antal glas
2. Glasstyp
3. Bokstavsbezeichnungar
4. Storlek och vällvning

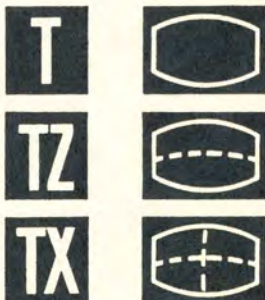

Rechteckform

Rectangular shape

Forme rectangulaire

Forma rectángular

Fyrkants formade



STERNKREUZ

Rechteckform, flach

Rechteckform für flachen Rand
Rectangular shape, for flat bezel
Forme rectangulaire, base plate
Rectángular, plano
Fyrkantsform för plan sarg



Rechteckform, flach, Ecken rund

Rechteckform für flachen Rand mit runden Ecken
Rectangular shape with round corners, for flat bezel
Forme rectangulaire avec des coins ronds, base plate
Rectángular con esquinas redondeadas, plano
Fyrkantsform för plan sarg med avrundade hörn



Rechteckform, flach, Ecken schräg

Rechteckform für flachen Rand mit schrägen Ecken
Rectangular shape with cut corners, for flat bezel
Forme rectangulaire avec des coins coupés, base plate
Rectángular con esquinas cortadas, plano
Fyrkantsform för plan sarg med rakt avklippta hörn



Rechteckform, flach, Ecken innenrund

Rechteckform für flachen Rand mit runden Ecken nach innen
Rectangular shape with concaved corners, for flat bezel
Forme rectangulaire avec des coins creusés, base plate
Rectángular con esquinas redondeadas hacia adentro, plano
Fyrkantsform för plan sarg med inåtsvängt avrundade hörn



Achteckform, gleichseitig, flach

Achteckform gleichseitig, für flachen Rand
Octagon shape, equilateral, for flat bezel
Forme octogonale équilatérale, base plate
Octagonal equilátero, plano
Liksidig åttkantform för plan sarg





R

Rechteckform, einseitig gebogen

Rechteckform, für einseitig gebogenen Rand
 Rectangular shape, for one side domed bezel
 Forme rectangulaire, bombé à un côté
 Rectángular, cóncavo en un sentido
 Fyrkantform för ensidigt böjd sarg

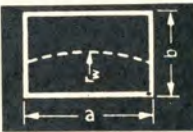

Rechteckform, einseitig gebogen, Ecken rund

Rechteckform für einseitig gebogenen Rand
 mit runden Ecken
 Rectangular shape with round corners, for one side
 domed bezel / Forme rectangulaire avec des coins
 ronds, bombé à une côté / Rectángular con
 esquinas redondeadas, cóncavo en un sentido /
 Fyrkantform för ensidigt böjd sarg med avrundade horn



Rechteckform, einseitig gebogen, Ecken schräg

Rechteckform für einseitig gebogenen Rand
 mit schrägen Ecken
 Rectangular shape with cut corners, for one side
 domed bezel / Forme rectangulaire avec des coins
 coupés, bombé à un côté / Rectángular con
 esquinas cortadas, cóncavo en un sentido /
 Fyrkantform för ensidigt böjd sarg med rakt
 avklippta hörn



Rechteckform, allseitig gebogen

Rechteckform, für allseitig gebogenen Rand
 Rectangular shape, for all sides domed bezel
 Forme rectangulaire, bombé à tous côtés
 Rectángular, cóncavo en ambos sentidos
 Fyrkantform för allsidigt böjd sarg



Rechteckform, allseitig gebogen, Ecken rund

Rechteckform für allseitig gebogenen Rand
 mit runden Ecken
 Rectangular shape with round corners, for all sides
 domed bezel / Forme rectangulaire avec des coins
 ronds, bombé à tous côtés / Rectángular con
 esquinas redondeadas, cóncavo en ambos sentidos
 Fyrkantform för allsidigt böjd sarg med
 avrundade hörn





Rechteckform

Rectangular shape
Forme rectangulaire
Forma rectangular
Fyrkant formade

Bestellzeichen Marks of order Marques de commande Signos de pedido Beställta tecken R	$a \times b - r_w$	Standard	Optik	Konkav
R	75x130		•	
R	75x140		•	
R	85x120		•	
R	90x 90	•		•
RX	90x 90-3			•
R	90x110		•	
R	90x140.1		•	
R	90x140.2Hoch		•	
R	95x 95	•	•	
RX	95x 95-2,5			•
R	95x120		•	
R	95x145		•	
RZ	95x180-2	•		
R	100x 90		•	
R	100x100	•	•	•
RX	100x100-2,5		•	
RZ	100x100-2,5		•	•
Rr	100x270		•	
R	105x 65	•		
Rr	105x 95			•
R	105x105	•	•	•
RX	105x105-2,5			•
R	105x115		•	
RZ	105x145-5			•
R	105x150		•	
R	110x 80		•	
R	110x 90		•	
R	110x100	•	•	•
RZ	110x100-4			•
R	110x105		•	•
RX	110x105-2,5		•	
R	110x110	•	•	•

Bestellzeichen Marks of order Marques de commande Signos de pedido Beställta tecken R	$a \times b - r_w$	Standard	Optik	Konkav
Rr	110x110			•
RX	110x110-2,5		•	•
RZ	110x110-4			•
RX	110x115-3		•	
R	110x120		•	
R	110x140		•	
R	115x 85	•		
R	115x100		•	
R	115x105	•		•
R	115x110			•
Rr	115x110			•
R	115x115	•	•	•
Rr	115x115		•	
Rs	115x115			•
RX	115x115-3			•
RX	115x115-2,5			•
RZ	115x115-5		•	
R	115x155		•	
R	120x 70	•		
R	120x 85		•	
R	120x 90	•		•
R	120x100		•	•
R	120x105		•	•
Rs	120x105			•
RX	120x105-3			•
R	120x110	•	•	•
RX	120x110-2,5		•	
R	120x115	•	•	•
R	120x120	•	•	•
Rs	120x120			•
RX	120x120-2,5		•	
RX	120x120-3		•	•
RZ	120x120-5		•	•
R	120x145		•	
RZ	120x145-2			•
RZ	120x150-4		•	•

Rectangular shape
Forme rectangulaire
Forma rectangular
Fyrkant formade

Rechteckform



Bestellzeichen Marks of order Marques de commande Signos de pedido Beställta tecken R	$a \times b - r_w$	Standard	Optik	Konkav
RZ	120x175-4			•
R	125x 65			•
R	125x 75		•	
R	125x 85		•	
R	125x 90		•	
R	125x100	•	•	•
R	125x105	•		•
R	125x110	•	•	•
R	125x115	•	•	•
RX	125x115-3			•
RZ	125x115-4		•	
R	125x120			•
Rs	125x120	•		
R	125x125	•	•	•
Rr	125x125			•
RX	125x125-3		•	•
RZ	125x125-5		•	
RZ	125x130-5		•	
R	125x135		•	
R	130x 70	•		
R	130x 75		•	
R	130x 80	•		•
R	130x 85	•	•	
R	130x 90	•		
R	130x100		•	•
RZ	130x100-6			•
R	130x105			•
RXs	130x105-4			•
R	130x110	•	•	•
RXr	130x110-5			•
R	130x115	•	•	•
Rr	130x115			•
RX	130x115-4			•
R	130x120	•	•	•
RX	130x120-4			•
RZ	130x120-6	•		•

Bestellzeichen Marks of order Marques de commande Signos de pedido Beställta tecken R	$a \times b - r_w$	Standard	Optik	Konkav
R	130x125			•
RZ	130x125-5			•
R	130x130	•		•
RX	130x130-3	•	•	•
RXs	130x130-3			•
RZ	130x130-5			•
R	130x135		•	
R	135x 70	•		
R	135x 85	•		
R	135x 90	•		
R	135x 95	•		
R	135x100			•
RZ	135x100-4		•	
R	135x105	•		•
R	135x110 ⁴			•
RX	135x110-4			•
RZ	135x110-4		•	
R	135x115	•	•	•
R	135x120	•	•	•
RX	135x120-3		•	
RX	135x120-4			•
R	135x125			•
RX	135x125-4			•
R	135x130		•	•
RX	135x130-3		•	
RX	135x130-4			•
R	135x135	•	•	•
Rr	135x135			•
RX	135x135-5	•		
RX	135x135-3			•
RX	135x135-6			•
RZ	135x135-4			•
RZ	135x135-3			•
R	135x145		•	
R	140x 75		•	
R	140x 80	•		•



STERNKREUZ

R



Rechteckform

Rectangular shape
Forme rectangulaire
Forma rectangular
Fyrkant formade

Bestellzeichen
Marks of order
Marques de commande
Signos de pedido
Beställta tecken
R a x b - r_w

Standard
Optik
Konkav

R	140x 90	●		●
R	140x 95		●	
Rs	140x 95	●		
R	140x100		●	●
R	140x105		●	
R	140x110		●	●
Rs	140x110	●		
RZ	140x110-4	●		
R	140x115		●	●
RX	140x115-4	●		
RZ	140x115-3			●
R	140x120	●	●	●
RX	140x120-4			●
RZ	140x120-4			●
R	140x125	●	●	●
RX	140x125-4			●
RZ	140x125-4	●		
R	140x130		●	●
RX	140x130-4		●	
R	140x135		●	●
RX	140x135-4		●	●
RZ	140x135-4		●	●
RZ	140x135-3			●
R	140x140	●	●	●
Rr	140x140		●	
RX	140x140-1,7	●		●
RX	140x140-3	●		●
RX	140x140-5		●	
RX	140x140-6	●		●
RZ	140x140-3		●	
RZ	140x140-8			●
R	141x141			●
RX	141x141-3			●
R	142x142			●
RX	142x142-3			●
R	143x143			●
RX	143x143-3			●

Bestellzeichen
Marks of order
Marques de commande
Signos de pedido
Beställta tecken
R a x b - r_w

Standard
Optik
Konkav

R	144x 84			●
R	144x144			●
RX	144x144-3			●
R	145x 85			●
R	145x100			●
R	145x105	●		●
R	145x110	●		●
Rr	145x110			●
RX	145x110-4			●
R	145x115	●		●
RX	145x115-3			●
RX	145x115-4			●
RZ	145x115-6			●
R	145x120			●
RX	145x120-4			●
R	145x125	●		●
RX	145x125-4			●
RZ	145x125-6			●
R	145x130			●
RX	145x130-3			●
R	145x135			●
RX	145x135-3			●
RZ	145x135-6			●
R	145x140			●
RX	145x140-3			●
RZ	145x140-3			●
RZ	145x140-15			●
R	145x145	●		●
RX	145x145-3			●
RX	145x145-6			●
RZ	145x145-3			●
RZ	145x145-6			●
R	145x150			●
R	146x146			●
RX	146x146-3			●
R	147x147			●

Rectangular shape
Forme rectangulaire
Forma rectangular
Rektant formade

Rechteckform



Bestellzeichen Marks of order Marques de commande Signos de pedido Beställa tecken R	a x b - r _w	Standard	Optik	Konkav
RX	147 x 147-3			●
R	148 x 148			●
RX	148 x 148-3			●
R	149 x 149			●
RX	149 x 149-3			●
R	150 x 80	●		●
R	150 x 90	●		
R	150 x 95	●	●	
R	150 x 100	●	●	●
RZ	150 x 100-6		●	
R	150 x 105	●		
R	150 x 110	●	●	●
Rs	150 x 110	●		
RZ	150 x 110-6		●	
R	150 x 115			●
R	150 x 120	●	●	●
RX	150 x 120-4	●		
RZ	150 x 120-6		●	●
R	150 x 125	●	●	
RX	150 x 125-4			●
RZ	150 x 125-6			●
R	150 x 130	●	●	●
RX	150 x 130-4			●
RZ	150 x 130-6		●	●
R	150 x 135		●	
RX	150 x 135-4			●
R	150 x 140	●	●	●
RX	150 x 140-3			●
R	150 x 145		●	●
RZ	150 x 145-6		●	
R	150 x 150	●	●	●
Ra	150 x 150			●
Rr	150 x 150	●	●	
RX	150 x 150-3	●	●	●
RX	150 x 150-6			●
RZ	150 x 150-8			●
Rs	150 x 240			●

Bestellzeichen Marks of order Marques de commande Signos de pedido Beställa tecken R	a x b - r _w	Standard	Optik	Konkav
R	151 x 151			●
RX	151 x 151-3			●
R	152 x 152			●
RX	152 x 152-3			●
R	153 x 153			●
RX	153 x 153-3			●
R	154 x 154			●
RX	154 x 154-3			●
R	155 x 70	●		
R	155 x 80			●
R	155 x 100		●	
R	155 x 105	●	●	●
RX	155 x 105-4			●
R	155 x 110	●	●	●
RX	155 x 110-4			●
R	155 x 115	●		
Rs	155 x 115	●		
RX	155 x 115-4		●	
R	155 x 120		●	●
RX	155 x 120-3			●
RX	155 x 120-4			●
RXr	155 x 120-3			●
RZ	155 x 120-6		●	●
R	155 x 125		●	●
RX	155 x 125-4			●
RX	155 x 125-6			●
RZ	155 x 125-4		●	
RZ	155 x 125-6			●
R	155 x 130		●	
R	155 x 135		●	
Ra	155 x 135			●
RZ	155 x 135-6		●	
R	155 x 140		●	●
RZ	155 x 140-6			●
R	155 x 145		●	●
RZ	155 x 145-6		●	●
RZ	155 x 150-8			●



STERNKREUZ



Rechteckform

Rectangular shape
Forme rectangulaire
Forma rectangular
Fyrkant formade

Bestellzeichen
Marks of order
Marques de commande
Signos de pedido
Beställa tecken
R a x b - r_w

Standard
Optik
Konkav

R	155x155	●	●	●
RX	155x155-5	●		
RX	155x155-3		●	●
RX	155x155-4			●
RXr	155x155-5			●
RZ	155x155-4		●	●
R	156x156			●
RX	156x156-3			●
R	157x157			●
RX	157x157-3			●
R	158x158			●
RX	158x158-4			●
R	159x159			●
RX	159x159-4			●
R	160x 70	●		
R	160x 80	●		
R	160x 85	●		
R	160x 90	●		●
R	160x 95		●	
R	160x100	●		
R	160x105		●	
R	160x110	●	●	●
Rr	160x110			●
R	160x115		●	●
R	160x120	●	●	●
Rs	160x120	●		
RX	160x120-4		●	●
RZ	160x120-4			●
R	160x125		●	●
RX	160x125-4			●
RZ	160x125-4		●	●
R	160x130	●	●	●
RX	160x130-4		●	
RZ	160x130-4		●	●
R	160x135		●	
RZr	160x135-8		●	●

Bestellzeichen
Marks of order
Marques de commande
Signos de pedido
Beställa tecken
R a x b - r_w

Standard
Optik
Konkav

R	160x140	●		●
RX	160x140-5		●	
R	160x145		●	●
RZ	160x145-8		●	
R	160x150	●	●	●
RX	160x150-5		●	●
RX	160x150-6			●
RZ	160x150-8		●	●
R	160x155		●	
R	160x160	●	●	●
Rr	160x160			●
RX	160x160-5	●		
RX	160x160-3			●
RX	160x160-4		●	●
RZ	160x160-4			●
R	161x161			●
RX	161x161-4			●
R	162x162			●
RX	162x162-4			●
R	163x163			●
RX	163x163-4			●
R	164x164			●
RX	164x164-4			●
R	165x 80		●	●
R	165x 90		●	●
R	165x100	●		●
Rs	165x100	●		●
RZ	165x100-8	●		
R	165x115		●	
R	165x120		●	
RX	165x120-4			●
R	165x125		●	●
RX	165x125-4		●	
RX	165x130-4			●
RXr	165x130-4			●
R	165x135		●	●

Rectangular shape
Forme rectangulaire
Forma rectangular
Fyrkant formade

Rechteckform



Bestellzeichen Marks of order Marques de commande Signos de pedido Beställa tecken R	a x b - r _w	Standard	Optik	Konkav
RX	165x135-4	●	●	●
RX	165x135-4		●	
RZ	165x135-4		●	
R	165x140			●
RZS	165x145		●	
R	165x155		●	●
R	165x165		●	●
RX	165x165-4			●
RZ	165x165-6			●
R	166x166			●
RX	166x166-4			●
R	167x167			●
RX	167x167-4			●
R	168x168			●
RX	168x168-4			●
R	169x169			●
RX	169x169-4			●
R	170x 70	●	●	
R	170x 85	●		
R	170x 90	●		
R	170x 95		●	
R	170x100	●	●	●
R	170x105	●		●
R	170x105		●	
RZ	170x105-4	●		
R	170x110	●	●	
R	170x115	●		
R	170x120		●	●
R	170x130		●	●
R	170x135		●	
RZ	170x135-4			●
R	170x140		●	
RX	170x140-4			●
RXr	170x145-5			●
RXs	170x145-4			●
R	170x150	●		●

Bestellzeichen Marks of order Marques de commande Signos de pedido Beställa tecken R	a x b - r _w	Standard	Optik	Konkav
RXr	170x150-4			●
R	170x155			●
RX	170x155-4			●
RX	170x160-4	●		●
RXr	170x160-4			●
R	170x165	●		
R	170x170	●	●	●
Ra	170x170	●		
Rr	170x170			●
RX	170x170-1,5	●		
RX	170x170-4		●	●
RX	170x170-5,0	●		
RZ	170x170-6			●
R	171x171			●
RX	171x171-4			●
R	172x172			●
RX	172x172-4			●
R	173x173			●
RX	173x173-4			●
R	174x174			●
RX	174x174-4			●
R	175x 90	●		
R	175x 95	●		
RZ	175x100-6	●		
R	175x105		●	●
Rs	175x105	●		●
R	175x110	●		●
Ri	175x110	●		
Rr	175x110	●		
RX	175x115-6		●	
RX	175x120-6	●	●	●
R	175x125			●
RZ	175x125-4			●
R	175x130		●	●
R	175x135	●		
RZr	175x135-4		●	



Rechteckform

Rectangular shape
Forme rectangulaire
Forma rectángular
Fyrkant formade

Bestellzeichen
Marks of order
Marques de commande
Signos de pedido
Beställa tecken
R a x b - r_w

Standard
Optik
Konkav

R	175x145	•	•	
R	175x150		•	•
RZ	175x150-4			•
RX	175x155-4			•
RZ	175x155-4	•	•	•
R	175x175	•	•	•
RX	175x175-4			•
RZ	175x175-6			•
RZ	175x220-8		□	
RZ	175x250-4		•	
R	176x176			•
RX	176x176-4			•
R	177x177			•
RX	177x177-4			•
R	178x178			•
RX	178x178-4			•
R	179x179			•
RX	179x179-4			•
R	180x 90		•	
R	180x100		•	
R	180x110	•		•
Rs	180x110	•		
RZ	180x110-4	•		•
R	180x120	•		•
R	180x125 REZN 49A WOC	•		•
R	180x130	•		•
RZ	180x130-5	•		
R	180x135			•
R	180x140 REON 96GW FLAT.	•		
Rr	180x140			•
R	180x145		•	
R	180x150	•	•	•
RX	180x155-4		•	•
R	180x165	•	•	•
RX	180x165-4		•	•
R	180x180	•	•	•

Bestellzeichen
Marks of order
Marques de commande
Signos de pedido
Beställa tecken
R a x b - r_w

Standard
Optik
Konkav

Ra	180x180			•
Rr	180x180		•	•
Rs	180x180			•
RX	180x180-4	•	•	•
RZ	180x180-6		•	•
R	181x181			
RX	181x181-4			•
R	182x182			•
RX	182x182-4			•
R	183x183			•
RX	183x183-4			•
R	184x184			•
RX	184x184-4			•
R	185x 85	•		
R	185x 95	•		
R	185x110	•		
R	185x115	•	•	•
RZ	185x115-10			•
R	185x120			•
RZS	185x120-3 ESO W8 3AM			•
RZ	185x120-8			•
R	185x125			•
Rr	185x135			•
R	185x140	•		
R	185x150			•
RX	185x150-4			•
R	185x155			•
RX	185x155-5		•	
RX	185x160-5			•
R	185x165			•
RZ	185x165-5	•		
RZ	185x180-6		•	
R	185x185	•	•	•
Rr	185x185		•	•
RX	185x185-4		•	•
RXr	185x185-4			•
RZ	185x185-6		•	•

- - Oberfläche facettiert
Surface bevelled
Surface facetée
Superficie facetada
Plan översida med fasettkant

Rectangular shape
Forme rectangulaire
Forma rectangular
Fyrkant formade

Rechteckform



Bestellzeichen Marks of order Marques de commande Signos de pedido Beställa tecken R	a x b - r _w	Standard	Optik	Konkav
R	186 x 186			●
RX	186 x 186-4			●
R	187 x 187			●
RX	187 x 187-4			●
R	188 x 188			●
RX	188 x 188-5			●
R	189 x 189			●
RX	189 x 189-5			●
R	190 x 80	●		
R	190 x 100		●	
Rs	190 x 100	●		
R	190 x 120	●		
RZ	190 x 120-3			●
R	190 x 125			●
Rr	190 x 135			●
R	190 x 135			●
R	190 x 140		●	●
Rr	190 x 155			●
RXr	190 x 155-5			●
RZr	190 x 155-10			●
R	190 x 160			●
R	190 x 180		●	●
R	190 x 190	●	●	●
Rs	190 x 190	●		
RX	190 x 190-5	●	●	●
RZ	190 x 190-6		●	●
RZ	190 x 225-7	●		
R	191 x 191			●
RX	191 x 191-5			●
R	192 x 192			●
RX	192 x 192-5			●
R	193 x 193			●
RX	193 x 193-5			●
R	194 x 194			●
RX	194 x 194-5			●

Bestellzeichen Marks of order Marques de commande Signos de pedido Beställa tecken R	a x b - r _w	Standard	Optik	Konkav
RZ	195 x 115-3			●
R	195 x 120			●
R	195 x 125	●		●
RX	195 x 125-5			●
R	195 x 130			●
R	195 x 135		●	
Rs	195 x 140	●		
RZ	195 x 150-3			●
RX	195 x 155-5	●		
R	195 x 165			●
R	195 x 175			●
RZ	195 x 180-10			●
R	195 x 185		●	●
R	195 x 195		●	●
Rr	195 x 195			●
RX	195 x 195-5	●	●	●
RZ	195 x 195-6		●	●
RZ	195 x 215-5,5		●	
RZ	195 x 225-4		●	
R	196 x 196			●
RX	196 x 196-5			●
R	197 x 197			●
RX	197 x 197-5			●
R	198 x 198			●
RX	198 x 198-5			●
R	199 x 199			●
RX	199 x 199-5			●
R	200 x 100	●		
RZ	200 x 110-5	●		
R	200 x 120	●		●
R	200 x 125			●
RZ	200 x 125-9	●		●
R	200 x 130	●		
Rs	200 x 130	●		
Rs	200 x 135	●		
R	200 x 140			●



STERNKREUZ

R



Rechteckform

Rectangular shape
Forme rectangulaire
Forma rectângular
Fyrkant formade

Bestellzeichen
Marks of order
Marques de commande
Signos de pedido
Beställa tecken
R a x b - r_w

Standard
Optik
Konkav

R	200x150	●		
R	200x155	●	●	
R	200x165	●		●
RZ	200x170-6			●
R	200x175		●	●
RX	200x175-4	●		●
RX	200x175-5		●	
RX	200x175-6			●
RZ	200x175-5	●		
R	200x180		●	●
Rr	200x180			●
RZ	200x180-6		●	
RZ	200x185-6		●	
R	200x190	●		
RZ	200x190-6		●	
RZ	200x190-10			●
RZ	200x195-10			●
R	200x200	●	●	●
Ra	200x200	●		
Rs	200x200	●		
RX	200x200-6	●		●
RZ	200x200-10	●		
RZ	200x205-10		●	
Rs	201x181		●	●
R	201x201		●	●
RX	201x201-6		●	●
RZ	202x202		●	●
RX	202x202-6		●	●
R	203x203		●	●
RX	203x203-5		●	●
R	204x204		●	●
RX	204x204-5		●	●
RZ	205x 90-5			●
RZ	205x105-7	●		
R	205x130	●		
RX	205x130			●

Bestellzeichen
Marks of order
Marques de commande
Signos de pedido
Beställa tecken
R a x b - r_w

Standard
Optik
Konkav

RZ	205x135-4			●
RZ	205x135-9	●		
R	205x170	●		
R	205x180	●		
RXr	205x180-5		●	
RXr	205x180-6			●
RZ	205x180-6		●	
RZ	205x180-10	●		
R	205x185	●		
R	205x190	●		
RX	205x190-5		□	●
Rr	205x195		●	
R	205x200		●	
RZ	205x200-10		●	
R	205x205	●	●	●
R	205x205		□	
RX	205x205-5			●
RZ	205x205-5	●		
RZ	205x205-10		●	●
RZ	205x225-12			●
R	206x206			●
RX	206x206-5			●
R	207x207			●
RX	207x207-5			●
R	208x208			●
RX	208x208-5			●
R	209x209			●
RX	209x209-5			●
R	210x100		●	
R	210x105		●	●
R	210x110			●
R	210x140	●	●	
RZ	210x140-7	●		
R	210x150			●
Rs	210x150			●
R	210x160	●		●

□ = Oberfläche facettiert
Surface bevelled
Surface facetée
Superficie faceteadă
Plan översida med fasettkant

Rectangular shape
Forme rectangulaire
Forma rectângular
Fyrkant formade

Rechteckform



Bestellzeichen Marks of order Marques de commande Signos de pedido Beställa tecken R a x b - f _w		Standard	Optik	Konkav	Bestellzeichen Marks of order Marques de commande Signos de pedido Beställa tecken R a x b - f _w		Standard	Optik	Konkav
R	210x170	●		●	R	215x150	●		●
RX	210x170-5		●		RZ	215x150-18	●		
RZ	210x170-6			●	RX	215x155-5		●	
RX	210x175-5		●		R	215x160	●	●	
R	210x180	●	●	●	RZ	215x160-6	●		
RX	210x180-5		●		Rr	215x165			●
R	210x185		●		RX	215x165-5			●
RX	210x185-5		●		R	215x170	●	●	●
R	210x190		●	●	Rr	215x170			●
RX	210x190-5		●	●	R	215x175		□	
R	210x195	●	●	●	R	215x175		●	
Rr	210x195		●		R	215x180	●		
RZ	210x195-6		●	●	Rs	215x180			●
R	210x200	●	●	●	R	215x185		●	
Rr	210x200		●	●	RX	215x185-5		●	
RX	210x200-5			●	RZ	215x185-6	●	●	●
RZ	210x200-6			●	R	215x190	●	●	●
R	210x205	●		●	RZ	215x190-6		●	
R	210x210		●	●	R	215x195			●
Rs	210x210	●	●	●	RX	215x195-4		□	
RX	210x210-5	●	●	●	R	215x200		●	
R	210x215		●		RX	215x200-5		●	
					R	215x210		●	
R	211x211			●	RZ	215x210-8		●	
RX	211x211-5			●	R	215x215	●	●	●
R	212x212			●	Ra	215x215			●
RX	212x212-5			●	Rs	215x215	●		
R	213x213			●	RX	215x215-5		□	●
RX	213x213-5			●	RZ	215x215-8	●	●	●
R	214x214			●	R	215x220		●	
RX	214x214-5			●					
					R	216x216			●
R	215x 90	●			RX	216x216-5			●
Rs	215x105	●			R	217x217			●
Rs	215x120	●			RX	217x217-5			●
RZr	215x135-10	●			R	218x 86			●
R	215x140	●			R	218x218			●
R	215x145	●			RX	218x218-5			●

SOK STERNKREUZ

R



Rechteckform

Rectangular shape
Forme rectangulaire
Forma rectangular
Fyrkant formade

Bestellzeichen
Marks of order
Marques de commande
Signos de pedido
Beställta tecken
R a x b - r_w

Standard
Optik
Konkav

R	219x219			●
RX	219x219-5			●
R	220x 90			●
R	220x120	●		
R	220x125	●		
Rr	220x130			●
Rr	220x140			●
R	220x145		●	●
R	220x150	●	●	
R	220x155	●		
RZ	220x155-6	●		
R	220x160		●	
R	220x165	●		
RZ	220x165-10	●		
R	220x170		●	●
RZ	220x170-6	●		
R	220x175	●	●	●
R	220x180	●	●	●
RZ	220x180-5	●		
R	220x185		●	
R	220x190		●	●
RX	220x190-5	●	●	●
R	220x195	●	●	
Rr	220x195		●	●
R	220x200 Extra Fl.			●
R	220x200		●	
RX	220x200-5			●
RZ	220x200-8			●
R	220x215	●		
R	220x220	●	●	●
RX	220x220-3,5	●		
RX	220x220-5			●
RX	220x220-10	●	●	●
RZ	220x220-8	●	●	
R	220x225		●	
R	221x221			●

□ = Oberfläche facettiert
Surface bevelled
Surface facetée
Superficie faceteada
Plan översida med fasettkant

Bestellzeichen
Marks of order
Marques de commande
Signos de pedido
Beställta tecken
R a x b - r_w

Standard
Optik
Konkav

RX	221x221-5			●
RZ	222x222			●
RX	222x222-5			●
R	223x223			●
RX	223x223-6			●
R	224x224			●
RX	224x224-6			●
R	225x110	●		
RZ	225x115-15		●	
R	225x125	●		
Ri	225x130	●		
RZ	225x135-8	●		
R	225x150	●		
RZ	225x150-5	●		
RZ	225x150-10	●		
R	225x155	●	●	
RX	225x155-5		●	
RZ	225x155-15	●	●	●
Rs	225x160	●		
RZ	225x160-8	●		
R	225x165	●	●	
R	225x170		●	●
RZ	225x170-8			●
RZ	225x170-10	●		
R	225x175	●	●	●
Rr	225x175	●		
R	225x180	●		
Rs	225x180	●		
RZ	225x180-8			●
R	225x185		●	●
RX	225x185-5		●	●
R	225x190	●		●
RZ	225x190-8			●
RX	225x195-5			●
RX	225x195-5		□	
RZ	225x195-8			●
R	225x200	●	●	

Rectangular shape
Forme rectangulaire
Forma rectangular
Fyrkant formade

Rechteckform



R

Bestellzeichen Marks of order Marques de commande Signos de pedido Beställa tecken R	$a \times b - r_w$	Standard	Optik	Konkav
RZ	225x200-8			•
R	225x205		•	
RZ	225x205-8			•
R	225x210	•	•	•
RZ	225x210-8			•
R	225x215		•	
Rr	225x215			•
RX	225x215-5	•		
RZ	225x215-10	•		
R	225x220		•	
Rr	225x220		•	
RZr	225x220-5		•	
R	225x225	•	•	•
Rr	225x225	•		
Rs	225x225	•		
RX	225x225-5		•	•
RX	225x225-5		□	
RX	225x225-6	•		
RZ	225x225-5	•	•	
RZr	225x225-5		•	
R	226x226			•
RX	226x226-6			•
R	227x227			•
RX	227x227-6			•
R	228x228			•
RX	228x228-6			•
R	229x229			•
RX	229x229-6			•
Rs	230x125	•		
Rs	230x130	•		
RZ	230x140-5	•		
RZ	230x140-6		•	
RZ	230x145-5	•		
RZ	230x150-8			•
R	230x155			•
R	230x160	•	•	•

Bestellzeichen Marks of order Marques de commande Signos de pedido Beställa tecken R	$a \times b - r_w$	Standard	Optik	Konkav
R	230x165	•		
RZ	230x165-5			•
R	230x170			•
RX	230x170-5			•
RZ	230x170-5			•
RZ	230x170-6	•		
RZ	230x170-12	•		
R	230x175	•		•
Rr	230x175	•		
RX	230x175-5		•	
RZ	230x175-5	•	•	
R	230x180			•
RX	230x180-5	•	•	
RZ	230x180-5	•	•	
R	230x185	•	•	•
RX	230x185-5		•	
RZ	230x185-5	•	•	
RZ	230x185-10	•		
RZ	230x185-15		•	
R	230x190		•	
RX	230x190-3,5		•	
R	230x195	•		
Rr	230x195			•
RZr	230x195-8		•	
R	230x200		•	
RX	230x205-5	•	•	•
R	230x210	•		•
RZ	230x210-8			•
R	230x215		•	
RX	230x215-4		•	
RZr	230x220-5		•	
R	230x225		•	
R	230x230	•	•	•
RX	230x230-3,5	•	•	•
RX	230x230-5	•	•	•
RX	230x230-12,5			•
RZ	230x230-5		•	
RZ	230x230-8	•		•



STERNKREUZ

R



Rechteckform

Rectangular shape
Forme rectangulaire
Forma rectângular
Fyrkant formade

Bestellzeichen
Marks of order
Marques de commande
Signos de pedido
Beställta tecken
R a x b - r_w

	Standard	Optik	Konkav
R	231 x 231		●
RX	231 x 231-6		●
R	232 x 232		●
RX	232 x 232-6		●
R	233 x 233		●
RX	233 x 233-5		●
R	234 x 234		●
RX	234 x 234-5		●
RZ	235 x 125-7	●	
R	235 x 135	●	
R	235 x 150		●
RZ	235 x 150-6	●	
R	235 x 155		●
RZ	235 x 155-6	●	
R	235 x 165		●
RZ	235 x 165-7	●	
R	235 x 175	●	●
R	235 x 180	●	●
Rr	235 x 180	●	●
RZ	235 x 180-6	●	
R	235 x 185	●	●
R	235 x 195	●	●
RZ	235 x 195-8	●	
RZ	235 x 195-9	●	
R	235 x 200	●	●
Rr	235 x 200	●	●
RZr	235 x 200-15	●	
RX	235 x 205-5	●	
RZ	235 x 205-8	●	
R	235 x 210	●	●
R	235 x 215	●	●
R	235 x 225	●	●
RZ	235 x 225-8	●	
R	235 x 230	●	●
RX	235 x 230-5	●	●
RXr	235 x 230-5	●	●
RZ	235 x 230-8	●	

Bestellzeichen
Marks of order
Marques de commande
Signos de pedido
Beställta tecken
R a x b - r_w

	Standard	Optik	Konkav
R	235 x 235	●	●
RX	235 x 235-5	●	●
RX	235 x 235-5	□	
RZ	235 x 235-8	●	
R	236 x 236		●
RX	236 x 236-5		●
R	237 x 237		●
RX	237 x 237-5		●
R	238 x 238		●
RX	238 x 238-5		●
R	239 x 239		●
RX	239 x 239-5		●
R	240 x 130	●	
R	240 x 150	●	
RZ	240 x 150-4	●	
RX	240 x 155-5		●
RZ	240 x 155-8		●
R	240 x 160	●	
RZ	240 x 160-8		●
RZ	240 x 160-10	●	
RZ	240 x 165-6	●	
RZ	240 x 165-10	●	
R	240 x 170	●	●
R	240 x 175	●	●
RZ	240 x 175-7	●	
RZ	240 x 175-10	●	
R	240 x 180	●	●
RX	240 x 180-6	●	●
R	240 x 185	●	●
RX	240 x 185-6	●	
RZ	240 x 185-10	●	
R	240 x 190	●	
R	240 x 200	●	●
RX	240 x 200-5	●	●
Rr	240 x 205	●	●
R	240 x 210	●	●

□= Oberfläche facettiert
Surface bevelled
Surface facetée
Superficie facetada
Plan översida med fasettkant

Rectangular shape
Forme rectangulaire
Forma rectangular
Fyrkant formade

Rechteckform



R

Bestellzeichen Marks of order Marques de commande Signos de pedido Beställa tecken R	$a \times b - r_w$	Standard	Optik	Konkav
RZ	240x210-8	•	•	
R	240x215		•	
R	240x220		•	
RX	240x220-6	•		
RX	240x235-5			•
R	240x240	•	•	•
Rs	240x240			•
RX	240x240-3,5	•		
RX	240x240-5	•	•	•
RXr	240x240-3,5			•
RXr	240x240-5			•
RZ	240x240-8	•		
R	241x241			•
RX	241x241-5			•
R	242x242			•
RX	242x242-5			•
R	243x243			•
RX	243x243-5			•
R	244x244			•
RX	244x244-5			•
Rs	245x140	•		
Rs	245x145			•
RZ	245x150-5	•		
RZ	245x150-8			•
R	245x160	•	•	•
RZ	245x160-7	•		
R	245x165	•	•	
RX	245x165-5	•		•
R	245x170			•
Rr	245x170	•		
RZ	245x170-6	•		
RZ	245x175-8			•
RX	245x180-6		•	
RZ	245x185-8			•
R	245x190	•		•
Rr	245x190			•

Bestellzeichen Marks of order Marques de commande Signos de pedido Beställa tecken R	$a \times b - r_w$	Standard	Optik	Konkav
RX	245x190-5			•
RX	245x190-6		•	
RZ	245x190-9	•		
Rr	245x195			•
RZ	245x195-10	•		
RZ	245x200-8			•
R	245x210		•	•
RZ	245x215-8			•
R	245x220		•	
RZ	245x220-8			•
R	245x235 Extra Fl.			•
R	245x245		•	•
RX	245x245-5	•	•	•
RXCL	245x245-75			•
R	246x246			•
RX	246x246-5			•
R	247x247			•
RX	247x247-5			•
R	248x248			•
RX	248x248-6			•
R	249x249			•
RX	249x249-6			•
RZ	250x140-5	•		
RX	250x150-5		•	
RZ	250x150-8		•	
R	250x155	•		
RZ	250x155-8	•		•
R	250x160			•
Rr	250x160.1			•
Rr	250x160.2			•
RZ	250x160-8			•
RZ	250x160-10	•		
R	250x165	•		
RZ	250x165-10	•		
R	250x170		•	•
RZ	250x170-8	•		•



STERNKREUZ



Rechteckform

Rectangular shape
Forme rectangulaire
Forma rectangular
Fyrkant formade

Bestellzeichen
Marks of order
Marques de commande
Signos de pedido
Beställa tecken
R a x b - r_w

		Standard	Optik	Konkav
RZ	250x170-15	●		
R	250x175	●		
RZ	250x175-6	●		
RZ	250x175-8			●
R	250x180	●		●
Rs	250x180	●		
RZ	250x180-8		●	
RZ	250x180-10	●		
R	250x185			●
RZ	250x185-8	●		
R	250x190		●	●
RX	250x190-3,5	●	●	
RX	250x190-5			●
RZ	250x190-10	●		
R	250x195			●
R	250x200	●		●
RZ	250x200-8	●		
R	250x210		●	
RX	250x210-6		●	
RZ	250x215-8	●		
R	250x230 Extra Fl.			●
R	250x230	●	●	
RX	250x230-6		●	●
RZ	250x235-8	●		
R	250x250	●		●
R	250x250 Extra Fl.			●
Rs	250x250	●		●
RX	250x250-5	●		
RX	250x250-6			●
RZ	250x250-8	●		
R	251x251			●
RX	251x251-6			●
R	252x252			●
RX	252x252-6			●
R	253x253			●
RX	253x253-6			●
R	254x254			●

Bestellzeichen
Marks of order
Marques de commande
Signos de pedido
Beställa tecken
R a x b - r_w

		Standard	Optik	Konkav
RX	254x254-6			●
R	255x125		●	
RZ	255x135-8	●		
R	255x155	●	●	
RX	255x155-5		●	
R	255x160			●
Rr	255x170	●		
RZ	255x170-10	●		
R	255x175			●
RZ	255x185-20	●		
R	255x190			●
RZ	255x190-5	●		
RZr	255x190-5	●		
R	255x195	●	●	●
RZ	255x195-10	●		
R	255x200	●	●	
R	255x205	●	●	
R	255x210	●		
RX	255x220-6		●	
RZ	255x220-10		●	
R	255x225	●		
R	255x255	●	●	●
Rr	255x255		●	
RX	255x255-5	●		
RX	255x255-6			●
RX	255x255-8			●
RXr	255x255-4			●
R	256x256			●
RX	256x256-6			●
R	257x257			●
RX	257x257-6			●
R	258x258			●
RX	258x258-5			●
R	259x259			●
RX	259x259-6			●

□ = Oberfläche facettiert
Surface bevelled
Surface facetée
Superficie faceteadă
Plan översida med fasettkant

Rectangular shape
Forme rectangulaire
Forma rectângular
Fyrkant formade

Rechteckform



R

Bestellzeichen Marks of order Marques de commande Signos de pedido Beställta tecken R	a x b - r _w	Standard	Optik	Konkav
R	260x120			•
Rr	260x120			•
Ra	260x130			•
R	260x140			•
Rr	260x140	•		
RZ	260x145-7	•		
R	260x160	•		
R	260x170	•	•	•
RX	260x170-5			•
RZ	260x170-8	•	•	
R	260x175		•	
RZ	260x175-9	•		
RZ	260x175-10			•
R	260x180	•		•
RX	260x180-6	•	•	•
RZ	260x180-10	•		
R	260x185		•	
RZ	260x185-8	•		•
R	260x190		•	•
RZ	260x190-8		•	•
R	260x195			•
R	260x200	•		
RX	260x200-3,5	•		
R	260x210			•
R	260x220	•	•	•
R	260x230	•	•	
RX	260x230-6	•	•	•
R	260x240		•	
R	260x260	•	•	•
RX	260x260-5			•
RX	260x260-6	•		
RX	260x260-8			•
RXCL	260x260 re-95			•
RXr	260x260-6			•
RZ	260x260-9	•		
R	265x120			•
Rr	265x120			•

Bestellzeichen Marks of order Marques de commande Signos de pedido Beställta tecken R	a x b - r _w	Standard	Optik	Konkav
RZ	265x175-6	•		
RZ	265x175-8		•	
R	265x185	•		•
RX	265x185-5		□	
R	265x190	•		
RX	265x190-6			•
RZ	265x190-8			•
RZ	265x190-10	•		
RZ	265x195-10	•		
RZ	265x200-8			•
R	265x205			•
RZ	265x205-6	•		
R	265x210			•
R	265x250			•
R	265x265	•		•
Rr	265x265			•
RX	265x265-5			•
RX	265x265-6	•	•	•
RXCL	265x265-100-8			•
RXrL	265x265-70			•
RXr	265x265-5			•
Rr	266x148			•
R	267x251			•
RZr	270x125			•
R	270x175	•		
Rr	270x175			•
R	270x180	•		
Rr	270x180			•
RZ	270x180-8		•	
RZr	270x180-8			•
R	270x185		•	
RZ	270x185-8			•
R	270x190		•	
Rr	270x190			•
Rs	270x190			•
RX	270x190-5	•		



STERNKREUZ



Rechteckform

Rectangular shape
Forme rectangulaire
Forma rectángular
Fyrkant formade

Bestellzeichen
Marks of order
Marques de commande
Signos de pedido
Beställa tecken
R a x b - r_w

Standard
Optik
Kontak

RZ	270x190-8		●	●
R	270x195			●
RZ	270x195-5	●		
RZs	270x195-10	●		
R	270x200	●		
RZ	270x200-8	●		
R	270x205	●		
R	270x210	●	●	●
Rr	270x210	●		
RZ	270x215-6			●
R	270x230 Extra Fl.			●
RZ	270x230-6			●
R	270x240 Extra Fl.			●
R	270x250			●
RXr	270x250-5			●
RX	270x260-5			●
R	270x270	●		●
RX	270x270-3	●		
RX	270x270-4	●		
RX	270x270-6		●	●
RXCL	270x270-95			●
RXr	270x270-5			●
RZ	270x270-9	●		
R	275x160	●		
RZ	275x160-10	●		
R	275x175			●
RZ	275x175-8	●		
RZ	275x180-8		□	
R	275x185			●
RZ	275x185-7	●		
RZ	275x185-8	●		
RZ	275x185-10	●		
R	275x190		●	
R	275x195	●		●
RX	275x195-5	●	●	
RZ	275x195-8			●
R	275x200			●

□ = Oberfläche facettiert
Surface bevelled
Surface facettée
Superficie facetçada

Plan översida med fasettkant

Bestellzeichen
Marks of order
Marques de commande
Signos de pedido
Beställa tecken
R a x b - r_w

Standard
Optik
Kontak

RZ	275x200-8	●	●	●
RZ	275x205-8			●
Rs	275x235	●		
R	275x275	●		●
RX	275x275-6	●		●
RZr	277x157			●
RZ	278x155-8	●		●
R	280x160	●		
Rs	280x160			●
RZ	280x170-8		●	
RZ	280x175-6	●		
RZr	280x175-6	●		
R	280x180	●	●	
RZ	280x180-8			●
RZ	280x190-6			●
R	280x200	●		●
RZ	280x200-9	●		
R	280x210	●		
RX	280x210-3,5	●		
RZr	280x210-6	●		
R	280x235	●		●
R	280x240			●
R	280x280		●	●
RX	280x280-6			●
RZr	281x157			●
RZ	285x155-8	●		
Rs	285x170			●
RZ	285x175-8			●
RZ	285x185-8	●	●	
R	285x190		●	●
RZ	285x190-8		●	
RZ	285x195-6	●		
R	285x200			●
RZr	285x220-9	●		

w. B. 278x218 REOV 08 GES
F. MIN. 278x218 REIN 06 GN



Bestellzeichen Marks of order Marques de commande Signos de pedido Beställa tecken R	$a \times b - r_w$	Standard	Optik	Konkav
Rr	285x285			●
Rr	290x160			●
Rr	290x180			●
Rr	290x190			●
RZ	290x195-6	●		
R	290x205	●		●
R	290x210	●		
RZ	290x230-6	●	●	●
RZ	290x290-5,5			●
R	295x160			●
R	295x235	●		
R	300x170	●		
RZs	300x205-8	●		
Rs	300x215	●		
RZr	300x215-9	●		
R	300x230			●
R	305x135			●
RZ	305x180-8	●		
RZs	305x220-9	●		
R	305x305	●		
RZ	310x190-9	●		
R	310x210	●		
RZ	315x200-8	●		
RZ	315x220-9	●		
Rr	320x155			●
R	320x190	●		

Bestellzeichen Marks of order Marques de commande Signos de pedido Beställa tecken R	$a \times b - r_w$	Standard	Optik	Konkav
RZr	330x225-9	●		
R	330x270	●		
RX	335x145			●
RZr	335x200-7	●		
RZ	335x205-9	●		
R	335x240	●		
R	340x150			●
RZ	340x150			●
RZr	340x200-8	●		
R	340x220	●		
RZ	345x205-7	●		
R	350x200			●
Rr	350x240			●
RZr	360x160			●
RZ	360x230-8	●		
RZr	365x130-5			●
R	370x215	●		
RZr	370x215-8	●		
R	390x130			●
Rr	400x140			●
R	440x270	●		
RZ	440x270-7	●		



Rechteckform

Rectangular shape
Forme rectangulaire
Forma rectángular
Fyrkant formade

Auf den Seiten 29 – 36 zeigen Ihnen die Abbildungen die genauen Abmessungen aller Rechteck-Formgläser mit runden Ecken, schrägen Ecken und runden Ecken nach innen.

Rechteckige Unterleggläser finden Sie auf den Seiten 115 – 129.

Den Radius bei den Gläsern für einseitig und allseitig gebogenen Rand zeigt Ihnen das Diagramm auf Seite 5.

The illustrations on pages 29 – 36 give you the exact measures of all rectangular fancy glasses with round edges (convex or concave) and bevelled edges.

Rectangular underlayed glasses can be found on pages 115 – 129.

The radius of glasses with curved edges on one side or all round are shown in the diagram on page 5.

Les illustrations pages 29 à 36 vous montrent les dimensions exactes de tous les verres de forme rectangulaires avec des angles ronds, obliques et incurvés vers l'intérieur.

Vous trouverez pages 115 à 129 les verres rectangulaires à talon.

Le Diagramme à la page 5 vous montre le rayon des verres avec base cintrée deux ou quatre côtés.

A las páginas 29 – 36 las ilustraciones les hacen ver las dimensiones de todos los cristales de forma rectangulares con ángulos redondos, ángulos biselados y ángulos redondos hacia adentro.

Cristales de apoyo rectangulares Vds. encuentran a las páginas 115 – 129.

El radio de los cristales para un borde curvado unilateral y a todos los lados les muestra el diagrama a la página 5.

På sidorna 29 – 36 visas avbildningar, med noggranna mått, på alla rektangulära formglas med in och utvändigt rundade eller skurna hörn.

Rektangulära underläggsglas finns på sidorna 115 – 129.

Skala för mätning av glassargens böjningsgrad finns på sidan 5.

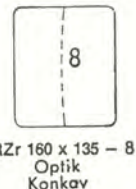
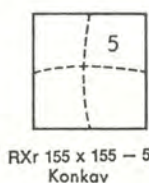
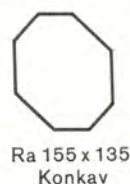
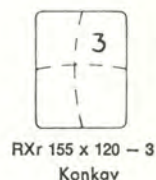
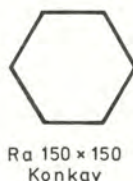
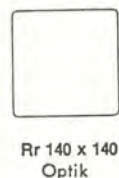
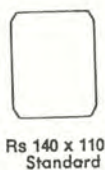
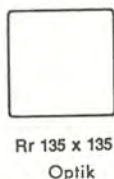
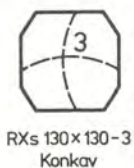
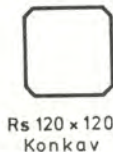
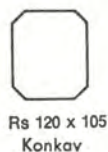
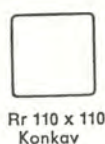
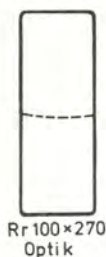



Rechteckform

Rectangular shape
Forme rectangulaire
Forma rectangular
Fyrkant formade



Rs 165 x 100
Standard
Konkav



RXr 165 x 130 - 4
Konkav

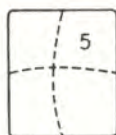

RXR 170 x 145 - 5
Konkav



RXs 170 x 145 - 4
Konkav

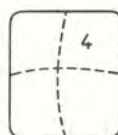

RXRr 170 x 150 - 4
Konkav

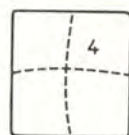

RXR 170 x 160 - 4
Konkav



Ra 170 x 170
Standard



Rr 170 x 170
Konkav



Rs 175 x 105
Standard
Konkav



Rr 175 x 110
Standard



Ri 175 x 110
Standard

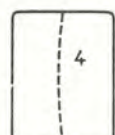

RZR 175 x 135 - 4
Optik



Rs 180 x 110
Standard



Rr 180 x 140
Konkav



Ra 180 x 180
Konkav



Rr 180 x 180
Optik
Konkav



Rs 180 x 180
Konkav



Rr 185 x 135
Optik



Rr 185 x 185
Optik
Konkav

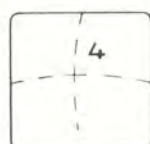

RXR 185 x 185 - 4
Konkav



Rs 190 x 100
Standard



Rr 190 x 135
Konkav

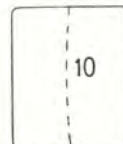

RZR 190 x 155 - 10
Konkav



RXR 190 x 155 - 5
Konkav



Rr 190 x 155
Konkav



Rs 190 x 190
Standard



Rs 195 x 140
Standard



Rr 195 x 195
Konkav

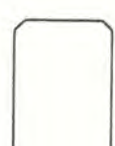

Rs 200 x 130
Standard

Rectangular shape
Forme rectangulaire
Forma rectángular
Fyrkant formade

Rechteckform



Rs 200 x 135
Standard



Rr 200 x 180
Konkav



Ra 200 x 200
Standard

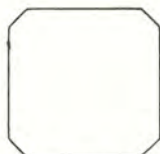

Rs 200 x 200
Standard

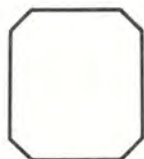

Rs 201 x 181
Konkav

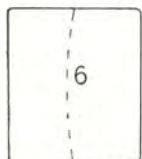

RZ 205 x 180 - 6
Konkav

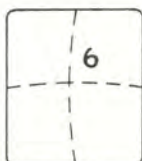

RXr 205 x 180 - 6
Optik



Rs 205 x 195
Optik



Rs 210 x 150
Konkav



Rr 210 x 195
Optik



Rr 210 x 200
Optik
Konkav

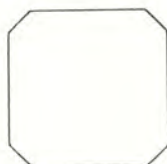

Rs 210 x 210
Standard
Konkav



Rs 215 x 105
Standard



Rs 215 x 120
Standard

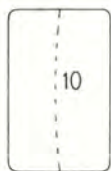

RZr 215 x 135 - 10
Standard



Rr 215 x 165
Konkav

S+K STERNKREUZ



Rechteckform

Rectangular shape
Forme rectangulaire
Forma rectangular
Fyrkant formade



Rr 215 x 170
Konkav

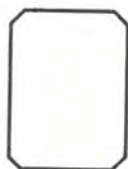

Rs 215x180
Konkav

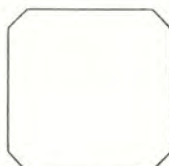

Rs 215 x 215
Standard



Ra 215 x 215
Konkav



Rr220x130
Konkav



Rr 220 x 140
Konkav



Rr 220 x 195
Optik



Rr 220x195
Konkav



Ri 225 x 130
Standard



Rs 225 x 160
Standard



Rr 225 x 175
Standard



Rs 225 x 180
Standard



Rr 225 x 215
Konkav



Rr 225 x 220
Optik

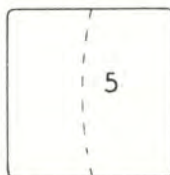

RZr 225 x 220 - 5
Optik

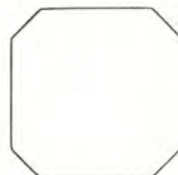

Rs 225 x 225
Standard

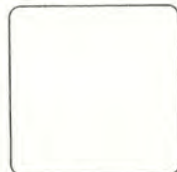

Rr 225 x 225
Standard

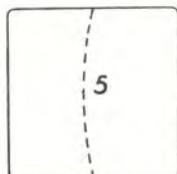

RZR 225 x 225 - 5
Optik



Rs 230 x 125
Standard



Rs 230 x 130
Standard

Rectangular shape
Forme rectangulaire
Forma rectángular
Fyrkant formade

Rechteckform



Rr 230 x 175
Standard



Rr 230 x 195
Konkav



RZr 230 x 195 - 8
Optik

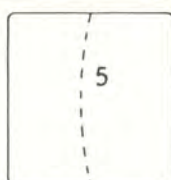

RZr 230 x 220 - 5
Optik



Rr 235 x 180
Standard



RZr 235 x 200 - 15
Optik



Rr 235 x 200
Konkav

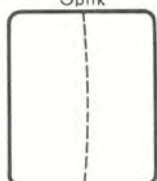

Rr 235 x 200
Optik

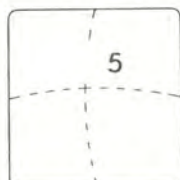

RXr 235 x 230 - 5
Konkav



Rs 240 x 150
Konkav



Rr 240 x 205
Optik



RXr 240 x 240 - 3,5
Konkav

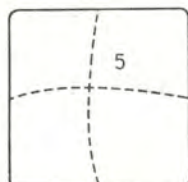

RXr 240 x 240 - 5
Konkav



Rs 240 x 240
Konkav



Rs 245 x 140
Standard



Rs 245 x 145



Rr 245 x 170
Standard



Rr 245 x 190
Konkav



Rr 245 x 195
Konkav



Rr 250 x 160
Konkav



STERNKREUZ



Rechteckform

Rectangular shape
Forme rectangulaire
Forma rectangular
Fyrkant formade

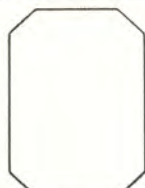

Rs 250 x 180
Standard

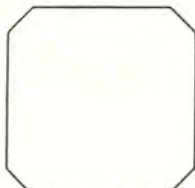

Rs 250 x 250
Standard



Rs 250 x 250
Konkav



Rr 255 x 170
Standard

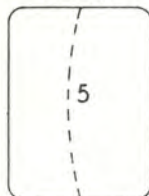

RZr 255 x 190 - 5
Standard

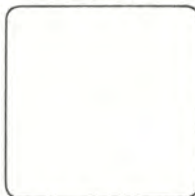

Rr 255 x 255
Optik

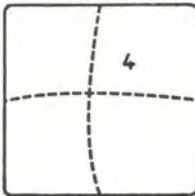

RXr 255 x 255 - 4
Konkav



Rr 260 x 120
Konkav



Ra 260 x 130
Konkav



Rr 260 x 140
Standard

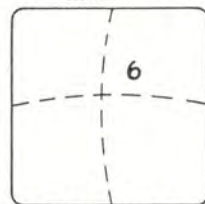

RXr 260 x 260 - 6
Konkav



Rr 265 x 120
Konkav

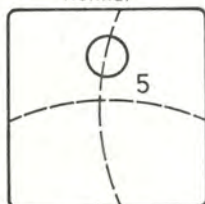

RXrCL 265 x 265 / 70 - 5
Konkav

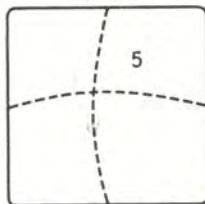

RXr 265 x 265 - 5
Konkav

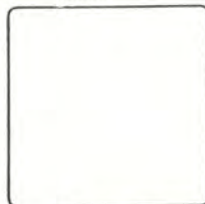

Rr 265 x 265
Konkav



Rr 266 x 148
Konkav



RZr 270 x 125
Konkav



Rr 270 x 175
Konkav



Rr 270 x 180
Konkav

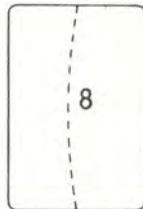

RZr 270 x 180 - 8
Konkav

Rectangular shape
 Forme rectangulaire
 Forma rectángular
 Fyrkant formade

Rechteckform

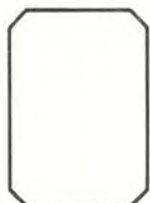

Rs 270 x 190
Konkav



Rr 270 x 190
Konkav

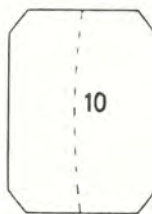

RZs 270 x 195 - 10
Standard



Rr 270 x 210
Standard



RXr 270 x 250-5
Konkav

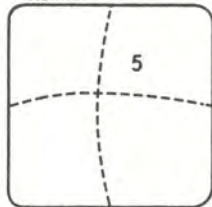

RXr 270 x 270 - 5
Konkav



Rs 275 x 235
Standard



RZr 277 x 157
Konkav



Rs 280 x 160
Konkav

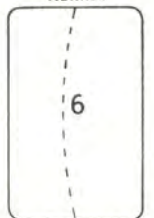

RZr 280 x 175 - 6
Standard

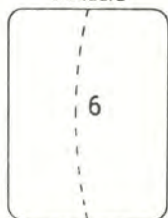

RZr 280 x 210 - 6
Standard



RZr 281 x 157
Konkav



Rs 285 x 170
Konkav

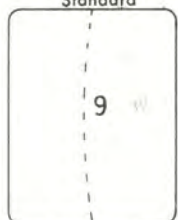

RZr 285 x 220 - 9
Standard

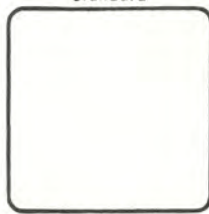

Rr 285 x 285
Konkav



Rr 290 x 160
Konkav



Rr 290 x 180
Konkav



Rr 290 x 190
Konkav

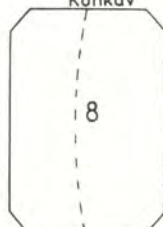

RZs 300 x 205 - 8
Standard



RZr 300 x 215 - 9
Standard



STERNKREUZ

R**Rechteckform**

Rectangular shape
 Forme rectangulaire
 Forma rectangular
 Fyrkant formade



Rs 300 x 215
 Standard

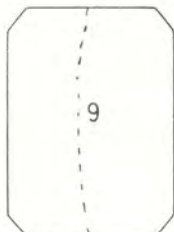

RZs 305 x 220 - 9
 Standard



Rr 320 x 155
 Konkav

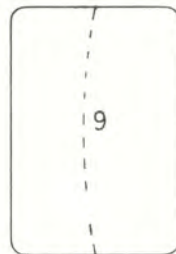

RZr 330 x 225 - 9
 Standard

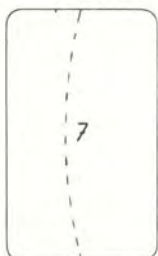

RZr 335 x 200 - 7
 Standard

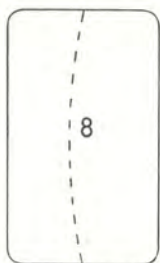

RZR 340 x 200 - 8
 Standard



Rr 350 x 240
 Konkav



RZr 360x160
 Konkav



RZr 365x130-5
 Konkav

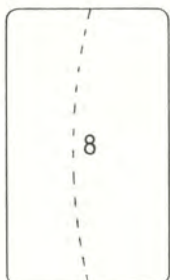

RZr 370 x 215 - 8
 Standard



Rr 400 x 140
 Konkav



Rechteckform

Rectangular shape
Forme rectangulaire
Forma rectangular
Fyrkant formade

Bestellzeichen Marks of order Marques de commande Signos de pedido Beställa tecken R	$a \times b - r_w$	Standard	Optik	Konkav
R	75x130		•	
R	75x140		•	
R	85x120		•	
R	90x 90	•		•
RX	90x 90-3			•
R	90x110		•	
R	90x140.1		•	
R	90x140.2Hoch		•	
R	95x 95	•	•	
RX	95x 95-2,5			•
R	95x120		•	
R	95x145		•	
RZ	95x180-2	•		
R	100x 90		•	
R	100x100	•	•	•
RX	100x100-2,5		•	
RZ	100x100-2,5		•	•
Rr	100x270		•	
R	105x 65	•		
Rr	105x 95			•
R	105x105	•	•	•
RX	105x105-2,5			•
R	105x115		•	
RZ	105x145-5			•
R	105x150		•	
R	110x 80		•	
R	110x 90		•	
R	110x100	•	•	•
RZ	110x100-4			•
R	110x105		•	•
RX	110x105-2,5		•	
R	110x110	•	•	•

Bestellzeichen Marks of order Marques de commande Signos de pedido Beställa tecken R	$a \times b - r_w$	Standard	Optik	Konkav
Rr	110x110			•
RX	110x110-2,5		•	•
RZ	110x110-4			•
RX	110x115-3		•	
R	110x120		•	
R	110x140		•	
R	115x 85	•		
R	115x100		•	
R	115x105	•		•
R	115x110			•
Rr	115x110			•
R	115x115	•	•	•
Rr	115x115		•	
Rs	115x115			•
RX	115x115-3			•
RX	115x115-2,5			•
RZ	115x115-5		•	
R	115x155		•	
R	120x 70	•		
R	120x 85		•	
R	120x 90	•		•
R	120x100		•	•
R	120x105		•	•
Rs	120x105			•
RX	120x105-3			•
R	120x110	•	•	•
RX	120x110-2,5		•	
R	120x115	•	•	•
R	120x120	•	•	•
Rs	120x120			•
RX	120x120-2,5		•	
RX	120x120-3		•	•
RZ	120x120-5		•	•
R	120x145		•	
RZ	120x145-2			•
RZ	120x150-4		•	•

R



Rechteckform

Rectangular shape
Forme rectangulaire
Forma rectangular
Fyrkant formade

Bestellzeichen
Marks of order
Marques de commande
Signos de pedido
Beställta tecken
R a x b - r_w

Standard
Optik
Konkav

R	140x 90	●		●
R	140x 95		●	
Rs	140x 95	●		
R	140x100		●	●
R	140x105		●	
R	140x110		●	●
Rs	140x110	●		
RZ	140x110-4	●		
R	140x115		●	●
RX	140x115-4	●		
RZ	140x115-3			●
R	140x120	●	●	●
RX	140x120-4			●
RZ	140x120-4			●
R	140x125	●	●	●
RX	140x125-4			●
RZ	140x125-4	●		
R	140x130		●	●
RX	140x130-4		●	
R	140x135		●	●
RX	140x135-4		●	●
RZ	140x135-4		●	●
RZ	140x135-3			●
R	140x140	●	●	●
Rr	140x140		●	
RX	140x140-1,7	●		●
RX	140x140-3	●		●
RX	140x140-5		●	
RX	140x140-6	●		●
RZ	140x140-3		●	
RZ	140x140-8			●
R	141x141			●
RX	141x141-3			●
R	142x142			●
RX	142x142-3			●
R	143x143			●
RX	143x143-3			●

Bestellzeichen
Marks of order
Marques de commande
Signos de pedido
Beställta tecken
R a x b - r_w

Standard
Optik
Konkav

R	144x 84			●
R	144x144			●
RX	144x144-3			●
R	145x 85			●
R	145x100			●
R	145x105	●		●
R	145x110	●		●
Rr	145x110			●
RX	145x110-4			●
R	145x115	●		●
RX	145x115-3			●
RX	145x115-4			●
RZ	145x115-6			●
R	145x120			●
RX	145x120-4			●
R	145x125	●		●
RX	145x125-4			●
RZ	145x125-6			●
R	145x130			●
RX	145x130-3			●
R	145x135			●
RX	145x135-3			●
RZ	145x135-6			●
R	145x140			●
RX	145x140-3			●
RZ	145x140-3			●
RZ	145x140-15			●
R	145x145	●		●
RX	145x145-3			●
RX	145x145-6			●
RZ	145x145-3			●
RZ	145x145-6			●
R	145x150			●
R	146x146			●
RX	146x146-3			●
R	147x147			●

R



Rechteckform

Rectangular shape
Forme rectangulaire
Forma rectângular
Fyrkant formade

Bestellzeichen
Marks of order
Marques de commande
Signos de pedido
Beställa tecken
R a x b - r_w

Standard
Optik
Konkav

R	200x150	●		
R	200x155	●	●	
R	200x165	●		●
RZ	200x170-6			●
R	200x175		●	●
RX	200x175-4	●		●
RX	200x175-5		●	
RX	200x175-6			●
RZ	200x175-5	●		
R	200x180		●	●
Rr	200x180			●
RZ	200x180-6		●	
RZ	200x185-6		●	
R	200x190	●		
RZ	200x190-6		●	
RZ	200x190-10			●
RZ	200x195-10			●
R	200x200	●	●	●
Ra	200x200	●		
Rs	200x200	●		
RX	200x200-6	●		●
RZ	200x200-10	●		
RZ	200x205-10		●	
Rs	201x181		●	●
R	201x201		●	●
RX	201x201-6		●	●
RZ	202x202		●	●
RX	202x202-6		●	●
R	203x203		●	●
RX	203x203-5		●	●
R	204x204		●	●
RX	204x204-5		●	●
RZ	205x 90-5			●
RZ	205x105-7	●		
R	205x130	●		
RX	205x130			●

Bestellzeichen
Marks of order
Marques de commande
Signos de pedido
Beställa tecken
R a x b - r_w

Standard
Optik
Konkav

RZ	205x135-4			●
RZ	205x135-9	●		
R	205x170	●		
R	205x180	●		
RXr	205x180-5		●	
RXr	205x180-6			●
RZ	205x180-6		●	
RZ	205x180-10	●		
R	205x185	●		
R	205x190	●		
RX	205x190-5		□	●
Rr	205x195		●	
R	205x200		●	
RZ	205x200-10		●	
R	205x205	●	●	●
R	205x205		□	
RX	205x205-5			●
RZ	205x205-5	●		
RZ	205x205-10		●	●
RZ	205x225-12			●
R	206x206			●
RX	206x206-5			●
R	207x207			●
RX	207x207-5			●
R	208x208			●
RX	208x208-5			●
R	209x209			●
RX	209x209-5			●
R	210x100		●	
R	210x105		●	●
R	210x110			●
R	210x140	●	●	
RZ	210x140-7	●		
R	210x150			●
Rs	210x150			●
R	210x160	●		●

□ = Oberfläche facettiert
Surface bevelled
Surface facetée
Superficie faceteadă
Plan översida med fasettkant

Rectangular shape
Forme rectangulaire
Forma rectangular
Fyrkant formade

Rechteckform



Bestellzeichen Marks of order Marques de commande Signos de pedido Beställta tecken R	$a \times b - r_w$	Standard	Optik	Konkav
RZ	120x175-4			•
R	125x 65			•
R	125x 75		•	
R	125x 85		•	
R	125x 90		•	
R	125x100	•	•	•
R	125x105	•		•
R	125x110	•	•	•
R	125x115	•	•	•
RX	125x115-3			•
RZ	125x115-4		•	
R	125x120			•
Rs	125x120	•		
R	125x125	•	•	•
Rr	125x125			•
RX	125x125-3		•	•
RZ	125x125-5		•	
RZ	125x130-5		•	
R	125x135		•	
R	130x 70	•		
R	130x 75		•	
R	130x 80	•		•
R	130x 85	•	•	
R	130x 90	•		
R	130x100		•	•
RZ	130x100-6			•
R	130x105			•
RXs	130x105-4			•
R	130x110	•	•	•
RXr	130x110-5			•
R	130x115	•	•	•
Rr	130x115			•
RX	130x115-4			•
R	130x120	•	•	•
RX	130x120-4			•
RZ	130x120-6	•		•

Bestellzeichen Marks of order Marques de commande Signos de pedido Beställta tecken R	$a \times b - r_w$	Standard	Optik	Konkav
R	130x125			•
RZ	130x125-5			•
R	130x130	•		•
RX	130x130-3	•	•	•
RXs	130x130-3			•
RZ	130x130-5			•
R	130x135		•	
R	135x 70	•		
R	135x 85	•		
R	135x 90	•		
R	135x 95	•		
R	135x100			•
RZ	135x100-4		•	
R	135x105	•		•
R	135x110			•
RX	135x110-4			•
RZ	135x110-4		•	
R	135x115	•	•	•
R	135x120	•	•	•
RX	135x120-3		•	
RX	135x120-4			•
R	135x125			•
RX	135x125-4			•
R	135x130		•	•
RX	135x130-3		•	
RX	135x130-4			•
R	135x135	•	•	•
Rr	135x135			•
RX	135x135-5	•		
RX	135x135-3			•
RX	135x135-6			•
RZ	135x135-4			•
RZ	135x135-3			•
R	135x145		•	
R	140x 75		•	
R	140x 80	•		•



STERNKREUZ

Rectangular shape
Forme rectangulaire
Forma rectangular
Rektant formade

Rechteckform



Bestellzeichen Marks of order Marques de commande Signos de pedido Beställa tecken R	a x b - r _w	Standard	Optik	Konkav
RX	147 x 147-3			●
R	148 x 148			●
RX	148 x 148-3			●
R	149 x 149			●
RX	149 x 149-3			●
R	150 x 80	●		●
R	150 x 90	●		
R	150 x 95	●	●	
R	150 x 100	●	●	●
RZ	150 x 100-6		●	
R	150 x 105	●		
R	150 x 110	●	●	●
Rs	150 x 110	●		
RZ	150 x 110-6		●	
R	150 x 115			●
R	150 x 120	●	●	●
RX	150 x 120-4	●		
RZ	150 x 120-6		●	●
R	150 x 125	●	●	
RX	150 x 125-4			●
RZ	150 x 125-6			●
R	150 x 130	●	●	●
RX	150 x 130-4			●
RZ	150 x 130-6		●	●
R	150 x 135		●	
RX	150 x 135-4			●
R	150 x 140	●	●	●
RX	150 x 140-3			●
R	150 x 145		●	●
RZ	150 x 145-6		●	
R	150 x 150	●	●	●
Ra	150 x 150			●
Rr	150 x 150	●	●	
RX	150 x 150-3	●	●	●
RX	150 x 150-6			●
RZ	150 x 150-8			●
Rs	150 x 240			●

Bestellzeichen Marks of order Marques de commande Signos de pedido Beställa tecken R	a x b - r _w	Standard	Optik	Konkav
R	151 x 151			●
RX	151 x 151-3			●
R	152 x 152			●
RX	152 x 152-3			●
R	153 x 153			●
RX	153 x 153-3			●
R	154 x 154			●
RX	154 x 154-3			●
R	155 x 70	●		
R	155 x 80			●
R	155 x 100		●	
R	155 x 105	●	●	●
RX	155 x 105-4			●
R	155 x 110	●	●	●
RX	155 x 110-4			●
R	155 x 115	●		
Rs	155 x 115	●		
RX	155 x 115-4		●	
R	155 x 120		●	●
RX	155 x 120-3			●
RX	155 x 120-4			●
RXr	155 x 120-3			●
RZ	155 x 120-6		●	●
R	155 x 125		●	●
RX	155 x 125-4			●
RX	155 x 125-6			●
RZ	155 x 125-6		●	
R	155 x 130		●	
R	155 x 135		●	
Ra	155 x 135			●
RZ	155 x 135-6		●	
R	155 x 140		●	●
RZ	155 x 140-6		●	
R	155 x 145		●	●
RZ	155 x 145-6		●	●
RZ	155 x 150-8			●



STERNKREUZ



Rechteckform

Rectangular shape
Forme rectangulaire
Forma rectangular
Fyrkant formade

Bestellzeichen
Marks of order
Marques de commande
Signos de pedido
Beställa tecken
R a x b - r_w

		Standard	Optik	Konkav
RZ	250x170-15	●		
R	250x175	●		
RZ	250x175-6	●		
RZ	250x175-8			●
R	250x180	●		●
Rs	250x180	●		
RZ	250x180-8		●	
RZ	250x180-10	●		
R	250x185			●
RZ	250x185-8	●		
R	250x190		●	●
RX	250x190-3,5	●	●	
RX	250x190-5			●
RZ	250x190-10	●		
R	250x195			●
R	250x200	●		●
RZ	250x200-8	●		
R	250x210		●	
RX	250x210-6		●	
RZ	250x215-8	●		
R	250x230 Extra Fl.			●
R	250x230	●	●	
RX	250x230-6		●	●
RZ	250x235-8	●		
R	250x250	●		●
R	250x250 Extra Fl.			●
Rs	250x250	●		●
RX	250x250-5	●		
RX	250x250-6			●
RZ	250x250-8	●		
R	251x251			●
RX	251x251-6			●
R	252x252			●
RX	252x252-6			●
R	253x253			●
RX	253x253-6			●
R	254x254			●

Bestellzeichen
Marks of order
Marques de commande
Signos de pedido
Beställa tecken
R a x b - r_w

		Standard	Optik	Konkav
RX	254x254-6			●
R	255x125		●	
RZ	255x135-8	●		
R	255x155	●	●	
RX	255x155-5		●	
R	255x160			●
Rr	255x170	●		
RZ	255x170-10	●		
R	255x175			●
RZ	255x185-20	●		
R	255x190			●
RZ	255x190-5	●		
RZr	255x190-5	●		
R	255x195	●	●	●
RZ	255x195-10	●		
R	255x200	●	●	
R	255x205	●	●	
R	255x210	●		
RX	255x220-6		●	
RZ	255x220-10		●	
R	255x225	●		
R	255x255	●	●	●
Rr	255x255		●	
RX	255x255-5	●		
RX	255x255-6			●
RX	255x255-8			●
RXr	255x255-4			●
R	256x256			●
RX	256x256-6			●
R	257x257			●
RX	257x257-6			●
R	258x258			●
RX	258x258-5			●
R	259x259			●
RX	259x259-6			●

□ = Oberfläche facettiert
Surface bevelled
Surface facetée
Superficie facetçada
Plan översida med fasettkant

Tonnenform

Barrel shape

Forme à tonneau

Forma de barril

Tunnformade



STERNKREUZ

■ Tonnenform, flach

Tonnenform, für flachen Rand
Barrel shape, for flat bezel
Forme à tonneau, base plate
Forma de barril, plano
Tunnform för plan sarg



■ Tonnenform, flach, Ecken rund

Tonnenform für flachen Rand mit runden Ecken
Barrel shape with round corners, for flat bezel
Forme à tonneau avec des coins ronds, base plate
Forma de barril con flancos rectos plano
Tunnform för plan sarg med avrundade hörn



■ Tonnenform, flach, gerade Flanken

Tonnenform für flachen Rand mit geraden Flanken
Barrel shape, straight flanked, for flat bezel
Forme à tonneau avec des flancs droits, base plate
Forma de barril con flancos rectos, plano
Tunnform för plan sarg med raka långsidor



■ Tonnenform, flach, Ecken schräg

Tonnenform, für flachen Rand mit schrägen Ecken
Barrel shape, with cut corners, for flat bezel
Forme à tonneau avec des coins coupés, base plate
Forma de barril con esquinas cortadas, plano
Tunnform för plan sarg med rakt avklippta hörn

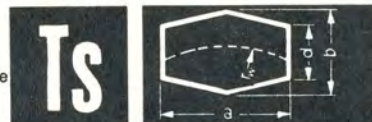

■ Sechseckform, flach

Sechseckform für flachen Rand
Hexagonal shape, for flat bezel
Forme hexagonale, base plate
Hexagonal, plano
Liksidig sexkantsform för plan sarg





■ ■ ■ ■ **Tonnenform, einseitig gebogen**

Tonnenform, für einseitig gebogenen Rand
Barrel shape, for one side domed bezel
Forme à tonneau, bombé à un côté
Forma de barril, cóncavo en un sentido
Tunnform för ensidigt böjd sarg



■ ■ ■ ■ **Sechseckform, einseitig gebogen**

Sechseckform, für einseitig gebogenen Rand
Hexagonal shape, for one side domed bezel
Forme hexagonale, bombé à un côté
Hexagonal, cóncavo en un sentido
Liksidig sexkantsform för ensidigt böjd sarg



■ ■ ■ ■ **Tonnenform, allseitig gebogen**

Tonnenform, für allseitig gebogenen Rand
Barrel shape, for all sides domed bezel
Forme à tonneau, bombé à tous côtés
Forma de barril, cóncavo en ambos sentidos
Tunnform för allsidigt böjd sarg



■ ■ ■ ■ **Tonnenform, allseitig gebogen, Ecken rund**

Tonnenform für allseitig gebogenen Rand
mit runden Ecken
Barrel shape with round corners, for all sides
domed bezel / Forme à tonneau avec des coins
ronds, bombé à tous côtés / Forma de barril con
esquinas redondeadas, cóncavo en ambos sentidos
Tunnform för allsidigt böjd sarg med
avrundade hörn



■ ■ ■ ■ **Sechseckform, allseitig gebogen**

Sechseckform, für allseitig gebogenen Rand
Hexagonal shape, for all sides domed bezel
Forme hexagonale, bombé à tous côtés
Hexagonal, cóncavo en ambos sentidos
Liksidig sexkantsform för allsidigt böjd sarg



SEIKO
ESINGTANCO
21.25 x 16.50 39

T



Tonnenform

Barrel shape
Forme à tonneau
Forma de barril
Tunnformade

Bestellzeichen
Marks of order
Marques de commande
Signos de pedido
Beställa tecken
T a x b x d

Standard
Optik
Konkav

Tr 80x165x130

T 85x110x105

T 100x120x 95

T 100x120x105

TX 100x120x105

T 100x145x110

Tr 100x160x130

Tr 100x205x190

Tr 100x340x255

T 105x105x 75

T 105x105x 80

TX 105x105x 90

TX 105x105x 95

Tr 105x125x110

T 105x130x105

Tr 105x130x115

T 105x165x140

Tr 105x270x225

T 110x110x 95

TZ 110x120x 90

T 110x125x 95

T 110x125x110

T 110x135x120

TXr 110x205x195

Tr 110x230x215

T 115x110x 75

TX 115x110x 85

TX 115x115x 75

TX 115x115x 95

T 115x115x100

TX 115x115x100

TX 115x125x105

Bestellzeichen
Marks of order
Marques de commande
Signos de pedido
Beställa tecken
T a x b x d

Standard
Optik
Konkav

T 115x135x110

T 115x140x115

T 115x140x130

T 115x145x130

T 115x150x105

T 115x165x125

T 120x100x 75

TX 120x100x 80

T 120x120x 65

T 120x120x 70

T 120x120x 90

TX 120x160x135

Te 120x165x100

T 120x165x150

Tr 120x200x150

Tr 120x210x175

TZ 124x245x177

TX 125x115x 90

T 125x120x 95

TX 125x120x 95

Te 125x120x 95

T 125x125x 90

TX 125x130x110

T 125x130x115

T 125x135x105

TX 125x135x115

TX 125x140x105

TX 125x155x130

TX 125x155x135

TX 125x160x135

TZ 125x160x140

T 125x200x100

T 130x120x110

T 130x125x 75

T 130x130x 70

12x135 8A ON 29A

Barrel shape
Forme à tonneau
Forma de barril
Tunnformade

Tonnenform



T

Bestellzeichen Marks of order Marques de commande Signos de pedido Beställa tecken T a x b x d		Standard	Optik	Konkav	Bestellzeichen Marks of order Marques de commande Signos de pedido Beställa tecken T a x b x d		Standard	Optik	Konkav
T	130x130x 90			•	T	150x105x 85	•		
TX	130x130x105		•		T	150x110x 85	•		
T	130x130x110			•	T	150x115x 60			•
TXe	130x145x100			•	TZ	150x115x 60			•
					T	150x115x 90	•		
TX	135x110x 90		•		T	150x120x 90		•	
T	135x115x 95	•			TXr	150x120x 90		•	
Te	135x125x100			•	T	150x120x 95	•		
Tg	135x130x 75			•	TXr	150x120x 95		•	•
Te	135x130x100			•	T	150x125x105	•		
T	135x130x120			•	Tg	150x130x 50			•
T	135x135x100		•		TXe	150x130x 60			•
TX	135x135x105			•	TX	150x135x115		•	
					Tg	150x145x110	•		
T	140x100x 85	•			Tr ^{1517S}	150x200x170			•
TX	140x115x100		•		Tr	150x230x 80			•
T	140x120x100			•	TZ	150x410x300			•
T	140x130x 55			•					
TX	140x130x 80			•	T	155x 80x 55	•		
T	140x130x105		•		TZ	155x115x 60			•
Te	140x135x 60			•	TX	155x115x 65		•	
TXr	140x170x150			•	T	155x120x 90	•		
Tr	140x180x145			•	T	155x120x 95	•		
T	140x245x210		•		TX	155x120x 95	•	•	
					TXr	155x120x 95			•
T	145x100x 85			•	T	155x125x 95	•		
T	145x115x 80	•			T	155x130x 40			•
T	145x115x 95			•	TXe	155x130x 70			•
Tg	145x120x 40			•	Te	155x130x 85	•		
T	145x120x 55			•	T	155x130x 90	•		
T	145x125x100			•	T	155x130x105	•		
T	145x125x105	•			TX	155x165x125			•
T	145x130x110	•	•		TX	155x165x130			•
TXs	145x135x 75			•	T	155x215x155	•		
T	145x135x100		•		Te	155x220x130			•
T	145x140x 85			•	T	155x260x140			•
Tr	145x170x150			•					
TX	145x190x125			•	T	156x 96x 80			•



STERNKREUZ

T



Tonnenform

Barrel shape
Forme à tonneau
Forma de barril
Tunnformade

Bestellzeichen
Marks of order
Marques de commande
Signos de pedido
Beställa tecken
T a x b x d

Standard
Optik
Konkav

T	160x100x	75	●		
T	160x105x	90	●		
T	160x115x	75		●	
Te	160x115x	75	●		
T	160x115x	80	●		
T	160x115x	85	●		
T	160x115x	100		●	
T	160x120x	85	●		
T	160x120x	95	●		
T	160x125x	105		●	
T	160x140x	90	●		
TX	160x160x	145		●	
Tr	160x240x	120		●	
Tr	160x300x	140		●	
T	165x105x	70	●		
T	165x110x	80	●		
T	165x115x	75	●		
T	165x115x	85	●		
Te	165x120x	80	●		
T	165x120x	95	●		
T	165x120x	100	●		
Tg	165x125x	90	●		
T	165x130x	90	●		
T	165x130x	110	●		
T	165x135x	105		●	
T	170x105x	75	●		
TZ	170x105x	85	●		
Tg	170x110x	65	●		
T	170x110x	75	●		
Tg	170x110x	75	●		
T	170x110x	80	●		
T	170x115x	80	●	●	
T	170x115x	85	●		
T	170x115x	95	●		
T	170x120x	85	●		
T	170x120x	90	●		●

Bestellzeichen
Marks of order
Marques de commande
Signos de pedido
Beställa tecken
T a x b x d

Standard
Optik
Konkav

T	170x125x	95	●		
TZ	170x130x	65-7			●
Tg	170x160x	110	●		
T	175x	95x 80	●		
Te	175x110x	70	●		
T	175x110x	80	●		
T	175x110x	90	●		
TZ	175x115x	80	●		
T	175x115x	110			●
Tg	175x125x	75	●		
Tr	175x145x	75			●
T	175x175x	115	●		
Tr	175x205x	175			●
T	175x270x	255			●
T	175x375x	200			●
T	180x	80x 60	●		
T	180x110x	90	●		
T	180x115x	85	●		
Te	180x120x	75	●		
T	180x120x	85	●		
T	180x130x	100	●		
T	180x145x	105	●		
T	180x180x	115	●		
Ts	180x245x	100			●
T	183x	277			●
Tg	185x125x	90	●		
Tg	185x135x	95	●		
T	185x185x	150			●
T	185x195x	105			●
T	185x230x	150			●
TX	185x230x	195			●
T	190x115x	65	●		
T	190x115x	75	●		
T	190x165x	135	●		
T	190x180x	120	●		

DATE = TR 18x175
18x175
183x277
ESONZ 1600
BAONZAL
BAON 67 AL00
BAIV.04.GN

Barrel shape
Forme à tonneau
Forma de barril
Tunnformade

Tonnenform



T

Bestellzeichen Marks of order Marques de commande Signos de pedido Beställa tecken T	a x b x d	Standard	Optik	Konkav
T	190x190x165		•	
TX	190x190x165			•
Te	195x125x 70	•		
T	195x125x 85	•		
Te	195x125x 85	•		
T	195x170x140	•		
TX	195x205x175		•	
Ter	195x215x110			•
TX	195x245x190			•
TZ	195x245x200			•
T	200x110x 80	•		
T	200x120x 90	•		
T	200x125x 90		•	
T	200x140x 80		•	
T	200x140x120	•		
T	200x175x155	•		
T	200x200x180	•		
TX	200x240x210			•
TZ	205x145x115	•		
T	205x190x150	•		
T	205x195x150	•		
T	205x205x175	•		
TX	205x205x195		•	
T	210x145x125	•		
T	210x175x155	•		
TX	210x180x160		•	
T	210x190x160	•		
TX	210x190x160	•		
T	210x195x125	•		
Te	210x200x170	•		
TX	210x205x170	•	•	
TX	210x205x175		•	
TXr	210x205x190		•	
TX	210x205x195		•	

Bestellzeichen Marks of order Marques de commande Signos de pedido Beställa tecken T	a x b x d	Standard	Optik	Konkav
TX	210x210x170		•	
TX	210x210x175	•		
TZ	210x210x175			•
TX	210x210x190		•	
T	210x230x160			•
TXr	210x230x210			•
TX	210x230x210 <i>210x280 BA 0W 80 GN</i> <i>210x285 BA 0W 86 GN</i>			•
TX	211x161x151			•
Tr	215x140x105			•
T	215x150x125		•	
TZ	215x160x135 <i>215x165 ESI W6 JAN 00</i>	•		
TZ	215x180x165		•	
Tg	215x185x100			•
T	215x185x145			•
T	215x190x150	•		
T	215x190x170	•		
T	215x195x165	•		
TX	215x200x150		•	
T	215x205x155	•		
TXs	215x205x165		•	
T	215x210x165	•		
TX	215x210x180	•	•	
TX	215x215x175			
T	215x215x175 <i>215x295 BA 0W 78 GN</i> <i>215x290 BA 0W 82 GN</i>			
T	220x140x100			
T	220x155x135	•		
T	220x160x125	•		
T	220x160x130	•		
T	220x165x140	•	•	
T	220x170x140	•		
T	220x175x150	•	•	
Te	220x180x120	•		
T	220x180x150	•	•	
T	220x185x155	•		
T	220x185x170	•		
T	220x190x135	•		
TX	220x190x160		•	



STERNKREUZ

T



Tonnenform

Barrel shape
Forme à tonneau
Forma de barril
Tunnformade

Bestellzeichen
Marks of order
Marques de commande
Signos de pedido
Beställa tecken
T a x b x d

Standard
Optik
Konkav

T 220x200x155
Te 220x200x165
T 220x200x180
TX 220x200x180
TX 220x205x170
TX 220x215x185
T 220x220x165
TX 220x220x200

T 225x125x 80
T 225x135x100
T 225x155x120
T 225x160x125
T 225x160x130
Tg 225x160x140

T 225x165x150
T 225x175x145

TZ 225x180x140

T 225x180x150

TZ 225x190x150

T 225x190x170

T 225x195x150

T 225x195x160

T 225x195x170

TZ 225x200x160

T 225x200x170

T 225x200x175

TZ 225x205x150

T 225x205x165

TX 225x205x165

TXe 225x205x170

TZ 225x205x175

TX 225x215x165

T 225x215x175

T 225x220x150

TX 225x220x190

TXr 225x250x210

□ = Oberfläche facettiert
Surface bevelled
Surface facettée
Superficie facetada
Plan översida med fasetkant

Bestellzeichen
Marks of order
Marques de commande
Signos de pedido
Beställa tecken
T a x b x d

Standard
Optik
Konkav

T 230x180x145

T 230x185x145

T 230x190x165

T 230x200x140

T 230x200x150

TZ 230x200x150

T 230x200x170

Tg 230x205x160

Te 230x205x165

TX 230x205x165

T 230x210x175

TX 230x210x175

T 230x215x175

TX 230x225x190

TX 230x225x195

TX 230x230x180

TZ 230x230x190

TX 230x230x195

TXr 230x250x210-5

T 235x160x130

Tr 235x170x130

T 235x170x150

T 235x175x155

T 235x180x150

T 235x185x155

T 235x190x170

T 235x195x160

T 235x195x165

TX 235x200x140

T 235x200x160

TX 235x200x160

TX 235x200x170

T 235x200x175

TZ 235x200x175

T 235x205x150

Te 235x205x170

TZ 235x205x170

Barrel shape
Forme à tonneau
Forma de barril
Tunnformade

Tonnenform



Bestellzeichen Marks of order Marques de commande Signos de pedido Beställta tecken T	a x b x d	Standard	Optik	Konkav
T	235x210x165	●		
T	235x220x150		●	●
T	235x220x170	●		
T	235x225x150	●		
T	235x230x155	●		
TX	235x235x170		●	
Tr	235x235x200		●	
TXr	235x240x210			●
Tr	235x245x205			●
Tr	240x130x110			●
Tr	240x150x110			●
TZ	240x170x130	●		
Te	240x170x150	●		
T	240x175x145		●	
Te	240x175x155	●		
T	240x180x145	●		
T	240x180x155	●		
TZ	240x180x165		●	
Te	240x185x160	●		
T	240x190x175	●		
Tg	240x195x100			●
T	240x200x150	●		
Tg	240x200x150	●		
T	240x200x165	●		
T	240x210x170	●		
T	240x230x160			●
TX	240x230x160	●		
TX	240x235x160			●
Te	240x260x130			●
TX	240x270x245			●
T	240x275x240			●
T	245x135x 90	●		
T	245x180x150	●		
T	245x185x150	●		
T	245x195x165	●		
TZ	245x195x165	●		

Bestellzeichen Marks of order Marques de commande Signos de pedido Beställta tecken T	a x b x d	Standard	Optik	Konkav
T	245x195x170	●		
TZ	245x200x150	●		
TZe	245x210x170	●		
Te	245x215x175	●		
TX	245x215x175			●
T	245x220x170	●		
TX	245x220x205		●	
TX	245x225x195		●	
TZ	245x230x180	●		
T	250x155x 90			●
T	250x160x110	●		
TZ	250x170x135	●		
T	250x175x135	●		
TZe	250x175x165	●		
T	250x180x150		●	
TZ	250x180x160	●		
T	250x185x150	●		
T	250x210x140	●		
T	250x210x175	●		
TX	250x210x190	●		
T	250x220x175	●		
TX	250x220x175			●
T	250x230x215			●
	250x250 <i>BA 60/190 62</i>			
T	251x324x257			●
T	255x195x170	●		
TX	255x195x170	●	●	
Te	255x215x150	●		
T	260x160x125	●		
T	260x180x135	●		
Te	260x180x140	●		
Te	260x185x140	●		
T	260x190x160	●		
Te	260x210x170	●		
T	260x220x170	●		●



STERNKREUZ



Tonnenform

Barrel shape
Forme à tonneau
Forma de barril
Tunnformade

Bestellzeichen
Marks of order
Marques de commande
Signos de pedido
Beställa tecken

T a x b x d

Standard
Optik
Konkav

TX 260x220x180
TX 260x230x195
T 260x250x195
Te 260x290x150

T 265x175x130
TZ 265x175x135
Tg 265x180x125
T 265x225x205

TZ 270x185x150
T 270x210x170
T 270x215x165
TX 270x275x260

TZ 275x195x160
T 275x220x190
TX 280x230x150
T 280x240x160

T 280x240x160

Auf den Seiten 47 - 51 zeigen Ihnen Abbildungen die genauen Abmessungen aller Tonnenform-Gläser mit runden Ecken, schrägen Ecken und geraden Flanken.

Tonnenförmige Unterleggläser finden Sie auf den Seiten 115 - 129.

Den Radius bei den Gläsern für allseitig und einseitig gebogenen Rand zeigt Ihnen das Diagramm auf Seite 5.

The illustrations on pages 47 - 51 show the exact measurements of all barrel shaped glasses with round edges, bevelled edges, and straight sides.

Barrel shaped underlaid glasses can be seen on pages 115 - 129.

The radius of glasses with curved edges on one side or all round are shown in the diagram on page 5.

Les illustrations pages 47 à 51 vous montrent les dimensions exactes de tous les verres de forme tonneau avec les angles ronds, obliques et des flancs droits.

Vous trouverez les verres de forme tonneau à talon pages 115 - 129.

Le Diagramme à la page 5 vous montre le rayon des verres avec base cintrée deux ou quatre côtés.

A las páginas 47 - 51 ilustraciones les muestran a Vds. las dimensiones precisas de todos los cristales de forma barril con ángulos redondos, ángulos biselados y flancos rectos.

Cristales de apoyo de forma barril Vds. encuentran a las páginas 115 - 129.

El radio de los cristales para borde curvado a todos los lados y unilateral les muestra a Vds. el diagrama a la página 5.

På sidorna 47 - 51 finnes måttatta avbildningar av tunnformade glas med avskurna långsidor och skurna eller rundade hörn.

Tunnformade underläggsglas visas på sidorna 115 - 129.

För angivande av böjningsgraden använd skalan på sidan 5.

277x183 BAIWQYAN

Bestellzeichen
Marks of order
Marques de commande
Signos de pedido
Beställa tecken

T a x b x d

Standard
Optik
Konkav

TZe 285x210x175

Tr 290x160x130

T 290x205x155

Te 290x210x140

T 290x255x160

Ts 295x235x105

T 300x250x210

T 300x270x170

TZr 310x140x100

T 310x210x135

T 310x210x145

T 315x215x155

T 350x230x170



Tr80×165×130
Optik



Tr100×160×130
Konkav



Tr 100×205×190
Konkav

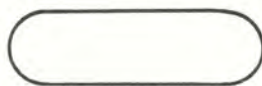

Tr 100 × 340 × 255
Konkav



Tr 105 x 125 x 110
Konkav



Tr 105 x 130 x 115
Konkav



Tr105×270×225
Konkav

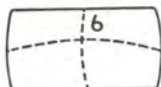

TXr 110 x 205 x 195
Optik

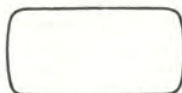

Tr 110 x 230 x 215
Konkav



Te 120 x 165 x 100
Konkav



Tr 120 x 200×150
Konkav



Tr 120×210×175
Konkav



Te 125×120×95
Konkav

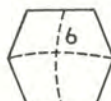

TXe 130 x 145 x 100
Konkav



Te 135 x 125 x 100
Konkav



Tg 135 x 130 x 75
Konkav



Te 135 x 130 x 100
Konkav



Te 140×135×060
Konkav



TXr 140 x 170 x 150
Konkav



Tr 140×180×145
Konkav



Tg 145 x 120 x 40
Konkav



TXs 145/140 x 135 x 75
Konkav



Tr 145×170×150
Konkav



TXr 150 x 120 x 90
Optik



TXr 150 x 120 x 95
Optik
Konkav



STERNKREUZ

T

Tonnenform

Barrel shape
Forme à tonneau
Forma de barril
Tunntormade



Tg 150x130x050
Konkav



TXe 150 x 130 x 60
Konkav



Tg 150 x 145 x 110
Standard



Tr 150x200 x 170
Konkav

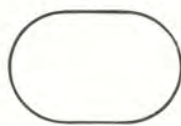

Tr 150x 230x080
Konkav



TXr 155 x 120 x 95
Konkav



TXe 155 x 130 x 70
Konkav



Te 155 x 130 x 85
Standard



Te 155x220x130
Konkav



Te 160x115x075
Standard



Tr 160 x 240 x 120
Konkav



Tr 160x300x140
Konkav



Te 165 x 120 x 80
Standard



Tg 165 x 125 x 90
Standard



Tg 170 x 110 x 65
Standard



Tg 170 x 110 x 75
Standard



Tg 170 x 160 x 110
Standard



Te 175 x 110 x 70
Standard



Tg 175 x 125 x 75
Standard



Tr 175x145x075
Konkav

Barrel shape
Forme à tonneau
Forma de barril
Tunnformade

Tonnenform



Tr 175 x 205 x 175
Konkav



Te 180 x 120 x 75
Standard

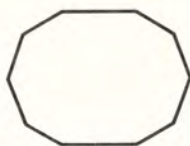

Ts 180 x 245 x 100
Konkav



Tg 185 x 135 x 95
Standard



Te 195 x 125 x 70
Standard



Te 195 x 125 x 85
Standard



Ter 195 x 215 x 110
Konkav



Te 210 x 200 x 170
Standard

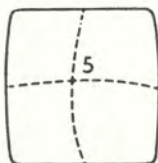

TXr 210 x 205 x 190
Optik

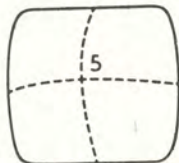

TXr 210 x 230 x 210
Konkav



Tr 215 x 140 x 105
Konkav



Tg 215 x 185 x 100
Konkav

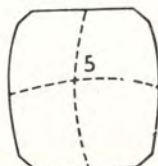

TXs 215 x 205 x 165
Optik



Te 220 x 180 x 120
Standard



Te 220 x 200 x 165
Standard



Tg 225 x 160 x 140
Standard



STERNKREUZ

T

Tonnenform

Barrel shape
Forme à tonneau
Forma de barril
Tunnformade

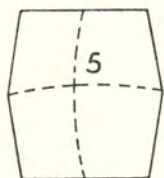

TXe 225 x 205 x 170
Optik

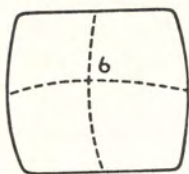

TXr 225 x 250 x 210
Konkav



Tg 230 x 205 x 160
Standard



Te 230 x 205 x 165
Standard

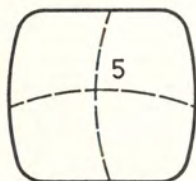

TXr 230 x 250 x 210
Konkav



Tr 235 x 170 x 130
Konkav



Te 235 x 205 x 170
Standard

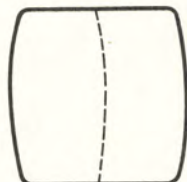

Tr 235 x 235 x 200
Optik



TXr 235 x 240 x 210
Konkav



Tr 235 x 245 x 205
Konkav



Tr 240 x 130 x 110
Konkav



Tr 240 x 150 x 110
Konkav



Te 240 x 170 x 150
Standard



Te 240 x 175 x 155
Standard



Te 240 x 185 x 160
Standard



Tg 240 x 195 x 100
Konkav

Barrel shape
 Forme à tonneau
 Forma de barril
 Tunnformade

Tonnenform



Tg 240 x 200 x 150
Standard

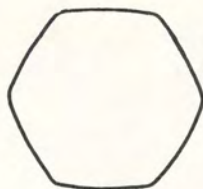

Te 240 x 260 x 130
Konkav

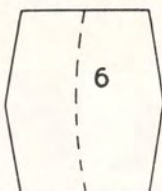

TZe 245 x 210 x 170
Standard



Te 245 x 215 x 175
Standard

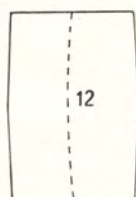

TZe 250 x 175 x 165
Standard

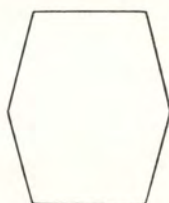

Te 255 x 215 x 150
Standard



Te 260 x 180 x 140
Standard



Te 260 x 185 x 140
Standard



Te 260 x 210 x 170
Standard



Te 260 x 290 x 150
Konkav



Tg 265 x 180 x 125
Standard

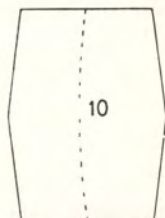

TZe 285 x 210 x 175
Standard



Tr 290 x 160 x 130
Konkav



Te 290 x 210 x 140
Konkav



Ts 295 x 235 x 105
Konkav



TZr 310 x 140 x 100
Konkav



STERNKREUZ



B

B

■ ■ ■ **Ballenform, einseitig gebogen**

Ballenform, für einseitig gebogenen Rand
 Bale shape, for one side domed bezel
 Forme à balle, bombé à un côté
 Forma de fardo, cóncavo en un sentido
 Ballform för ensidigt böjd sarg

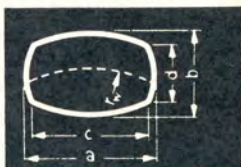

■ ■ ■ **Ballenform, einseitig gebogen, Ecken rund**

Ballenform für einseitig gebogenen Rand mit runden Ecken
 Bale shape with round corners, for one side domed bezel
 Forme à balle avec des coins ronds, bombé à un côté
 Forma de fardo con esquinas redondeadas, cóncavo en un sentido
 Ballform för ensidigt böjd sarg med avrundade hörn

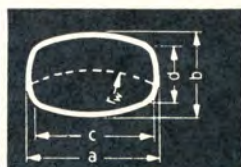

■ ■ ■ **Ballenform, allseitig gebogen**

Ballenform, für allseitig gebogenen Rand
 Bale shape, for all sides domed bezel
 Forme à balle, bombé à tous côtés
 Forma de fardo, cóncavo en ambos sentido
 Ballform för allsidigt böjd sarg



■ ■ ■ **Ballenform, allseitig gebogen, Ecken rund**

Ballenform mit runden Ecken, für allseitig gebogenen Rand
 Bale shape with round corners, for all sides domed bezel
 Forme à balle avec des coins ronds, bombé à tous côtés
 Forma de fardo con esquinas redondeadas, cóncavo en ambos sentidos
 Ballform för allsidigt böjd sarg med avrundade hörn



SEIKO
 SAZNTIANOO
 23x18

B**Ballenform**
Bale shape
Forme à balle
Forma de fardo
Balform

Bestellzeichen Marks of order Marques de commande Signos de pedido Beställa tecken B a/c x b/d	Standard	Optik	Konkav	Bestellzeichen Marks of order Marques de commande Signos de pedido Beställa tecken B a/c x b/d	Standard	Optik	Konkav
B 100/ 90x100/ 90		●		Br 125/115x125/115			●
B 105/ 95x105/ 95			●	B 130/125x100/ 90			●
B 110/ 95x110/ 95	●	●	●	Br 130/115x110/ 90			●
B 110/100x110/ 80			●	Br 130/110x115/ 95			●
BX 110/100x110/100			●	B 130/120x115/105			●
Br 115/105x110/100			●	Br 130/105x120/ 90			●
B 115/100x115/100			●	Br 130/110x120/100			●
B 115/105x115/105			●	B 130/120x120/ 85			●
B 120/115x110/100			●	B 130/120x120/105			●
Br 120/105x115/ 95			●	B 130/110x125/100			●
B 120/110x115/ 95			●	B 130/100x130/100			●
B 120/100x120/100		●	●	Br 130/110x130/105			●
BX 120/100x120/100			●	B 130/108x130/108			●
B 120/100x120/110			●	B 130/110x130/110		●	●
B 120/105x120/105			●	Br 130/110x130/110			●
B 120/110x120/110			●	Bg 130/110x130/110			●
Br 120/115x120/115			●	B 130/115x130/115			●
B 124/114x119/ 96			●	BX 130/115x130/115			●
B 125/110x105/ 90		●		B 130/120x130/120		●	●
B 125/110x110/ 90			●	Br 135/110x105/ 85			●
B 125/115x110/100			●	Br 135/120x105/100			●
Br 125/105x115/ 90			●	Br 135/125x105/100			●
BX 125/115x115/105			●	B 135/110x110/ 85			●
B 125/110x120/ 90			●	BXr 135/115x110/ 90			●
BX 125/110x120/ 90			●	Br 135/120x110/ 90			●
B 125/110x120/105			●	B 135/120x110/100			●
Br 125/115x120/100			●	BXr 135/125x110/ 95			●
B 125/120x120/100			●	BX 135/130x115/105			●
B 125/ 95x125/ 95			●	B 135/125x120/110			●
B 125/105x125/105			●	Br 135/125x125/110			●
B 125/110x125/105			●	B 135/110x130/100			●
B 125/110x125/110			●	Br 135/110x130/110			●
BX 125/110x125/110		●		BX 135/125x130/ 80			●
				B 135/105x135/105			●
				B 135/115x135/115			●
				BX 135/115x135/115			●

Bale shape
Forme à balle
Forma de fardo
Balform

Ballenform



B

Bestellzeichen Marks of order Marques de commande Signos de pedido Beställa tecken B a/c x b/d		Standard	Optik	Konkav	Bestellzeichen Marks of order Marques de commande Signos de pedido Beställa tecken B a/c x b/d		Standard	Optik	Konkav
B	135/120x135/120			●	B	145/120x145/120		●	●
Br	135/120x135/120			●	Br	145/120x145/120			●
B	135/125x135/105			●	B	145/125x145/125			●
B	135/110x140/120		●		BX	145/125x145/125			●
B	140/120x115/ 95			●	BX	145/130x145/130			●
Br	140/120x120/100			●	B	145/130x145/130			●
B	140/130x120/100			●	B	145/135x145/135			●
B	140/120x125/100			●	Br	145/135x145/135			●
B	140/125x125/100			●	B	146/138x128/114			●
BX	140/120x130/105			●	B	148/135x122/ 89			●
Br	140/125x130/110			●	Br	150/135x110/ 85			●
B	140/130x130/115			●	Br	150/135x115/105			●
B	140/125x135/115			●	Br	150/130x120/ 85			●
B	140/110x140/110		SAO N 51 A N		BX	150/140x120/105			●
B	140/120x140/120	●	●	●	Br	150/145x125/115			●
Br	140/120x140/120		●	●	BX	150/120x130/ 85			●
B	140/125x140/125			●	BX	150/130x130/105		●	●
B	143/118x143/118			●	BZ	150/130x130/110		●	
Br	145/125x105/ 80			●	B	150/135x130/100			●
Br	145/125x110/ 95			●	B	150/135x130/105			●
B	145/125x115/ 95			●	B	150/135x130/115			●
Br	145/130x115/110			●	BX	150/135x130/120			●
Br	145/130x120/105			●	BX	150/140x130/ 95			●
B	145/120x125/105			●	B	150/145x130/105			●
BX	145/130x125/105			●	Br	150/130x135/105			●
BX	145/135x125/ 90			●	BX	150/125x140/105			●
B	145/135x125/100			●	B	150/130x140/125			●
BX	145/140x125/ 90			●	Br	150/135x145/130			●
BX	145/100x130/115			●	Br	150/120x150/120		SAO N 9 51 A N	●
BX	145/120x130/120			●	B	150/125x150/125			●
Br	145/100x140/ 90			●	BX	150/130x150/130			●
Br	145/125x140/115			●	B	150/135x150/135			●
BX	145/135x140/ 85			●	BX	150/135x150/135			●
B	145/115x145/115			●	B	150/140x150/140			●
					B	154/137x140/127			●



STERNKREUZ

B



Ballenform

Bale shape
Forme à balle
Forma de fardo
Balform

Bestellzeichen
Marks of order
Marques de commande
Signos de pedido
Beställa tecken
B a/c x b/d

Standard
Optik
Konkav

B 155/130x115/ 95 ●
 Br 155/145x115/105 ●
 Br 155/130x125/100 ●
 B 155/135x125/100 ●
 BX 155/135x125/100 ●
 B 155/140x125/ 90 ●
 BX 155/130x130/115 ●
 BXr 155/135x130/ 90 ●
 BXr 155/135x130/110 ●
 B 155/140x135/115 ●
 BXr 155/130x145/120 ●
 Br 155/140x150/135 ●
 Br 155/145x150/140 ●
 BX 155/130x155/130 ●
 B 155/135x155/135 ●

B 158/153x102/ 76 ●

Br 160/140x125/105 ●

B 160/150x130/110 ●

Br 160/150x130/115 ●

Br 160/140x135/110 ●

B 160/145x140/ 80 ●

BX 160/140x150/140 ●

B 160/145x150/135 ●

B 160/130x160/130 ●

B 160/135x160/135 ●

BX 160/140x160/140 ●

B 160/145x160/145 ●

BX 160/145x160/145 ●

BX 160/150x160/150 ●

Br 161/145x130/105 ●

B 163/148x140/113 ●

163x153 SAIN 73 GN 00 FLAT.

BX 165/150x140/ 85 ●

Br 165/155x140/ 60 ●

Bestellzeichen
Marks of order
Marques de commande
Signos de pedido
Beställa tecken
B a/c x b/d

Standard
Optik
Konkav

BXr 165/140x145/100 ●

FLAT 165x155 BX 165/150x145/125 ●

BX 165/140x165/140 ●

BX 165/145x165/145 ●

Br 170/160x120/ 90 ●

B 170/150x125/105 ●

B 170/150x125/115 ●

Br 170/135x130/ 90 ●

B 170/155x130/100 ●

B 170/160x165/150 ●

BX 170/160x165/150 ●

Br 170/135x170/135 ●

Br 170/140x170/140 ●

B 170/150x170/150 ●

BX 170/150x170/150 ●

BX 170/150x170/160 ●

B 170/155x170/155 ●

B 173/152x155/132 ●

Br 175/155x135/ 95 ●

B 175/170x145/135 ●

Br 175/140x140/120 ●

B 175/160x155/130 ●

B 175/160x160/140 ●

Br 175/140x175/140 ●

Br 180/165x140/ 75 ●

B 180/165x145/115 ●

B 180/165x145/135 ●

BX 180/170x155/130 ●

18x16 SAIN 73 GN 00 FLAT. BX 180/160x175/160 ●

BX 180/160x180/160 ●

B 180/170x180/170 ●

BXr 180/170x180/170 ●

□ = Oberfläche facettiert
 Surface bevelled
 Surface facettée
 Superficie faceteada
 Plan översida med fasettkant

Bale shape
Forme à balle
Forma de fardo
Balform

Ballenform



Bestellzeichen Marks of order Marques de commande Signos de pedido Beställa tecken B	a/c x b/d	Standard	Optik	Konkav
Br	185/160x125/ 90			•
Br	185/175x125/115	•	•	
Br	185/165x130/115			•
B	185/170x170/145			•
BX	185/170x185/170			•
Br	190/160x150/120			•
B	190/170x150/110			•
Br	190/150x155/110			•
B	190/175x155/120			•
Br	190/160x160/110			•
B	190/150x190/150			•
Br	190/150x190/150			•
B	190/155x190/155			•
B	195/180x145/110			•
Br	195/150x195/150			•
Br	197/157x197/157			•
B	200/195x135/110			•
Br	200/170x160/120			•
Br	200/175x170/145			•
B	200/155x200/155			•
B	200/170x200/170	•		•
BX	200/170x200/170			•
B	200/180x200/175			•
Br	201/165x198/165			•
Br	202/180x202/180			•
Br	204/165x201/165			•
B	205/185x140/120			•
Br	205/160x175/125			•
B	205/190x175/150			•
B	205/195x175/160			•
B	205/195x180/165			•

Bestellzeichen Marks of order Marques de commande Signos de pedido Beställa tecken a/c x b/d	Standard	Optik	Konkav
Br	210/195x150/125		•
BX	210/190x190/165	•	
BZr	210/195x205/190		•
BX	210/190x210/190	•	•
B	210/200x210/200	•	
Br	215/190x115/ 90		•
Br	215/195x115/ 90		•
B	215/210x120/ 60		•
Br	215/190x135/ 85		•
Br	215/195x135/115		•
B	215/195x180/150		•
Br	215/180x190/175		•
B	215/190x190/165		•
BXr	215/195x215/195	•	•
Br	220/205x145/115		•
Br	220/185x165/115		•
Br	220/180x175/125		•
B	220/185x215/175	•	
BX	220/200x215/200		•
BX	220/190x220/190	•	
B	220/195x220/195		•
BX	220/195x220/195		•
BX	220/200x220/200		•
BX	225/190x150/140		•
Br	225/169x170/130		•
B	225/215x200/185		•
BXr	225/205x210/190		•
BXr	225/205x210/190		□
BX	225/210x210/175		•
B	225/190x220/190	•	
BX	225/195x225/195		•
BXr	225/200x225/200		•
BZr	225/215x225/200	•	
BZr	225/215x225/220	•	•

210x17 SAINZIAN



STERNKREUZ

B



Ballenform

Bale shape
Forme à balle
Forma de fardo
Balform

Bestellzeichen
Marks of order
Marques de commande
Signos de pedido
Beställa tecken
B a/c x b/d

Standard
Optik
Konkav

BZ 230/220x140/110

B 230/215x145/95

B 230/200x200/160

Br 230/205x200/155

BX 230/205x200/180

BX 230/210x225/210

B 230/205x230/205

BX 230/210x230/210

B 235/205x160/115

BX 235/225x195/180

BX 235/210x205/175

BX 235/220x210/170

BX 235/210x215/180

BX 235/215x230/200

BX 235/195x235/195

B 240/230x120/100

Br 240/200x185/145

BZr 240/210x185/170

B 240/220x190/140

BX 240/220x210/170

BX 240/205x220/170

BX 240/215x220/175

BX 240/205x225/195

BXr 240/220x225/190

B 240/215x230/170

BXr 240/225x230/210

BX 240/200x240/200

BX 240/215x240/215

B 245/230x165/140

BZr 245/230x175/160

BX 245/235x180/165

B 245/205x185/170

BZr 245/205x185/170

BX 245/195x245/195

BX 245/215x245/215

Bestellzeichen
Marks of order
Marques de commande
Signos de pedido
Beställa tecken
B a/c x b/d

Standard
Optik
Konkav

Br 250/210x145/100

BZr 250/210x185/170

Br 250/230x200/175

Br 250/200x220/180

B 250/235x240/210

B 250/225x250/225

B 250/230x250/230

Br 255/210x205/160

BXr 255/230x235/200

B 255/225x255/225

BX 255/225x255/225

B 255/230x255/230

BZr 260/235x200/175

B 260/235x220/180

BX 260/230x260/230

BX 260/230x260/230-5

BXr 260/230x260/230

B 265/240x230/160

B 265/250x240/220

B 265/240x255/225

BX 265/240x255/225

BX 265/240x265/240

Br 269/220x269/220

270x175

B 270/250x135/95

B 270/255x235/215

Br 270/235x240/200

B 270/250x240/205

BX 270/250x240/205

272x177 REOV

Br 275/265x125/95

270x255 SAON

BZ 275/255x145/105

Br 275/255x245/225

Br 275/210x250/190

BX 275/255x260/235

8x 230x180

SAZ N7 1A WOO

BACW4 UGN

ZZ GN
96 GN

FAT

Bale shape
Forme à balle
Forma de fardo
Ballform

Ballenform



B

Bestellzeichen Marks of order Marques de commande Signos de pedido Beställa tecken B a/c x b/d	Standard	Optik	Konkav
Br 275/240x265/170			●
Br 275/230x275/230			●
BX 275/240x275/240			●
B 278/223x278/223			●
Br 280/240x200/165			●
Br 280/255x200/165			●
BX 280/260x265/235			●
BX 280/260x265/240			●
Br 280/220x280/220			●
Br 280/240x280/240			●
BX 280/240x280/240			●
BX 280/245x280/245			●
B 280/250x280/250			●
BX 280/250x280/250			●
Br 280/225x290/140			●
Br 285/265x150/110			●
B 285/275x195/175			●
Br 285/250x205/175			●
BZ 285/260x215/160	●		●
B 285/245x245/195			●
BXr 285/235x250/200			●
B 285/240x265/210			●
BX 285/255x285/255			●
B 287/250x262/217			●
Bs 290/245x200/175			●
Br 290/260x220/180			●
Br 290/230x260/190			●

Bestellzeichen Marks of order Marques de commande Signos de pedido Beställa tecken B a/c x b/d	Standard	Optik	Konkav
BX 290/260x290/260			●
Br 290/270x290/270			●
Bs 292/277x240/216			●
Br 295/275x160/130			●
Br 295/250x295/250			●
Br 300/255x225/145			●
Br 300/250x230/145			●
Br 300/265x255/195			●
Br 300/260x260/220			●
Br 300x300 SAZWI 7LE40			●
B 302/287x218/185			●
Br 304/260x304/260			●
Br 305/260x250/180			●
Br 305/245x275/210			●
Br 305/250x300/245			●
Br 315/280x265/195			●
BZr 325/315x265/255			●
B 330/305x240/205			●
Br 335/295x205/135			●
Br 340/280x275/200			●
Br 395/375x150/ 85			●

Sämtliche Ballenform-Gläser sind auf den Seiten 60 - 79 abgebildet.

The complete range of bale shaped glasses is shown on pages 60 - 79.

Tous les verres de forme balle figurent pages 60 à 79.

Todos los cristales abombados son representados a las páginas 60 - 79.

Samtliga glas av ballenform är avbildade på sidorna 60 - 79.



STERNKREUZ

B**Ballenform**

Bale shape
Forme à balle
Forma de fardo
Balform



B 100/90 X 100/90
 Optik



B 105/95 X 105/95
 Konkav



B 110/95 X 110/95
 Standard
 Optik
 Konkav



B 110/100 X 110/90
 Konkav



BX 110/100 X 110/100
 Konkav



Br 115/105 X 110/100
 Konkav



B 115/100 X 115/100
 Konkav



B 115/105 X 115/105
 Konkav



B 120/115 X 110/100
 Konkav



Br 120/105 X 115/95
 Konkav



B 120/110 X 115/95
 Konkav



B 120/100 X 120/100
 Konkav
 Optik



BX 120/100 X 120/100
 Konkav



B 120/100 X 120/110
 Konkav



B 120/105 X 120/105
 Konkav



B 120/110 X 120/110
 Konkav



Br 120/115 X 120/115
 Konkav



B 125/110 X 105/90
 Optik



Br 125/110 X 110/90
 Konkav



B 124/114 X 119/96
 Konkav



B 125/115 X 110/100
 Konkav



Br 125/105 X 115/90
 Konkav



BX 125/115 X 115/105
 Konkav



B 125/110 X 120/90
 Konkav



BX 125/110 X 120/90
 Konkav



B 125/110 X 120/105
 Konkav



Te 125 X 120 X 95
 Konkav



Br 125/115 X 120/100
 Konkav



B 125/120 X 120/100
 Konkav



B 125/95 X 125/95
 Konkav

Bale shape
Forme à balle
Forma de fardo
Ballform

Ballenform



B



B 125/105 X 125/105
Konkav



B 125/110 X 125/105
Konkav



B 125/110 X 125/110
Konkav



BX 125/110 X 125/110
Optik



Br 125/115 X 125/115
Konkav



B 130/125 X 100/90
Konkav



Br 130/115 X 110/90
Konkav



Br 130/110 X 115/95
Konkav



B 130/120 X 115/105
Konkav



Br 130/105 X 120/90
Konkav



Br 130/110 X 120/100
Konkav



B 130/120 X 120/85
Konkav



B 130/120 X 120/105
Konkav



B 130/110 X 125/100
Konkav

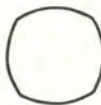

B 130/100 X 130/100
Konkav



Br 130/110 X 130/105
Konkav



B 130/108 130/108
Konkav

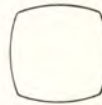

B 130/110 X 130/110
Optik
Konkav



Br 130/110 X 130/110
Konkav



Bg 130/110 X 130/110
Konkav



BX 130/115 X 130/115
Konkav



B 130/115 X 130/115
Konkav



B 130/120 X 130/120
Optik
Konkav



Br 135/110 X 105/85
Konkav



Br 135/120 X 105/100
Konkav



Br 135/125 X 105/100
Konkav



B 135/110 X 110/85
Konkav



BX 135/115 X 110/90
Konkav



Br 135/120 X 118/98
Konkav



B 135/120 X 118/108
Konkav



STERNKREUZ

B**Ballenform**

Bale shape
Forme à balle
Forma de fardo
Balform



BXr $135/125 \times 110/95$
 Konkav



BX $135/130 \times 115/105$
 Konkav



B $135/125 \times 120/110$
 Konkav



Br $135/125 \times 125/110$
 Konkav



B $135/110 \times 130/100$
 Konkav



Br $135/110 \times 130/110$
 Konkav

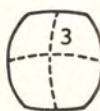

BX $135/125 \times 130/100$
 Konkav



B $135/105 \times 135/105$
 Konkav



BX $135/115 \times 135/115$
 Konkav



B $135/115 \times 135/115$
 Konkav



B $135/120 \times 135/120$
 Konkav



Br $135/120 \times 135/120$
 Konkav



B $135/125 \times 135/105$
 Konkav



B $135/110 \times 140/120$
 Optik



B $140/120 \times 115/95$
 Konkav



Br $140/120 \times 120/100$
 Konkav



B $140/130 \times 120/100$
 Konkav



B $140/120 \times 125/100$
 Konkav



B $140/125 \times 125/100$
 Konkav

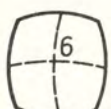

BX $140/120 \times 100/105$
 Konkav



Br $140/125 \times 130/110$
 Konkav



B $140/130 \times 130/115$
 Konkav



B $140/125 \times 135/115$
 Konkav



B $140/110 \times 140/110$
 Konkav



B $140/120 \times 140/120$
 Standard
 Optik
 Konkav



Br $140/120 \times 140/120$
 Optik
 Konkav



B $140/125 \times 140/125$
 Konkav



B $143/118 \times 143/118$
 Konkav



Br $145/125 \times 105/080$
 Konkav



Br $145/125 \times 110/95$
Konkav



B $145/125 \times 115/95$
Konkav



Br $145/130 \times 115/110$
Konkav



Br $145/130 \times 120/105$
Konkav



B $145/120 \times 125/105$
Konkav



BX $145/130 \times 125/105$
Konkav



BX $145/125 \times 125/90$
Konkav



B $145/135 \times 125/100$
Konkav



BX $145/110 \times 125/90$
Konkav



BX $145/100 \times 120/115$
Konkav



BX $145/120 \times 120/120$
Konkav



Br $145/100 \times 140/90$
Konkav



Br $145/125 \times 140/115$
Konkav

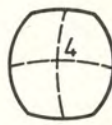

BX $145/125 \times 140/85$
Konkav



B $145/115 \times 145/115$
Konkav



B $145/120 \times 145/120$
Optik
Konkav



Br $145/120 \times 145/120$
Konkav



B $145/125 \times 145/115$
Konkav

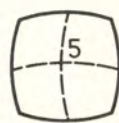

BX $145/125 \times 145/125$
Konkav



BX $145/120 \times 145/120$
Konkav



B $145/130 \times 145/130$
Konkav



B $145/135 \times 145/135$
Konkav



Br $145/135 \times 145/135$
Konkav



B $146/138 \times 128/114$
Konkav

B**Ballenform**

Bale shape
Forme à balle
Forma de fardo
Balforn



B 148
 $135 \times 122 / 89$
 Konkav



Br 150/135 X $110/85$
 Konkav



Br 150/135 X $115/105$
 Konkav



Br 150/130 X $120/85$
 Konkav



BX 150/148 X $120/105$
 Konkav



Br 150/145 X $125/115$
 Konkav



BX 150/120 X $130/85$
 Konkav



BX 150/120 X $130/105$
 Optik



BZ 150/130 X $130/110$
 Optik



B 150
 $135 \times 130 / 100$
 Konkav



B 150/135 X $130/105$
 Konkav



B 150/135 X $130/115$
 Konkav



BX 150/135 X $100/120$
 Konkav



BX 150/140 X $130/85$
 Konkav



B 150/145 X $130/105$
 Konkav



Br 150/130 X $135/105$
 Konkav



BX 150/120 X $140/105$
 Konkav



B 150/130 X $140/125$
 Konkav



Br 150/135 X $145/130$
 Konkav



Br 150
 $120 \times 150 / 120$
 Konkav



B 150
 $125 \times 150 / 125$
 Konkav



BX 150/130 X $150/130$
 Konkav



B 150
 $135 \times 150 / 135$
 Konkav



BX 150/135 X $150/135$
 Konkav



B 150/140 X $150/140$
 Konkav

Bale shape
Forme à balle
Forma de fardo
Ballform

Ballenform



B 154/137 x 140/127
Konkav



B 155/130 X 115/95
Konkav



Br 155/145 X 115/105
Konkav



Br 155/130 X 125/100
Konkav



B 155/135 X 125/100
Optik

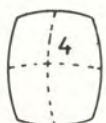

BX 155/135 X 125/100
Optik



B 155/140 x 125/90
Konkav



BX 155/130 X 130/115
Konkav



BXr 155/135 X 130/90
Konkav



BXr 155/135 X 130/110
Konkav



B 155/140 x 135/115
Konkav

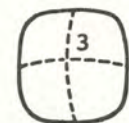

BXr 155/130 X 145/120
Konkav



Br 155/140 X 150/135
Konkav



Br 155/145 X 150/140
Konkav



BX 155/130 X 155/130
Konkav



B 160/130 X 160/120
Konkav



B 158/153 x 102/7076
Konkav



Br 160/110 X 125/105
Konkav



B 160/150 X 130/110
Konkav



Br 160/150 x 130/115
Konkav



Br 160/140 X 130/110
Konkav



B 160/145 X 140/90
Konkav



BX 160/140 X 150/140
Konkav



B 160/145 X 150/135
Konkav



B 160/130 X 160/130
Standard
Konkav



STERNKREUZ

B**Ballenform**

Bale shape
Forme à balle
Forma de fardo
Balform



B $160/135 \times 160/135$
 Konkav

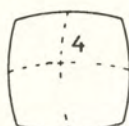

BX $160/140 \times 160/140$
 Konkav



BX $160/145 \times 160/145$
 Konkav



B $160/145 \times 160/145$
 Konkav



BX $160/150 \times 160/150$
 Konkav



Br $161/145 \times 130/105$
 Konkav



B $163/148 \times 140/113$
 Konkav



BX $165/150 \times 140/85$
 Konkav



Br $165/155 \times 140/60$
 Konkav

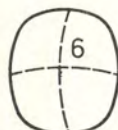

BXr $165/140 \times 145/100$
 Konkav



BX $165/150 \times 145/125$
 Konkav



BX $165/140 \times 145/140$
 Konkav



BX $165/145 \times 165/145$
 Konkav



Br $170/140 \times 120/90$
 Konkav



B $170/150 \times 125/105$
 Konkav



B $170/150 \times 125/115$
 Konkav



Br $170/135 \times 120/90$
 Konkav



B $170/155 \times 130/100$
 Konkav



B $170/160 \times 145/150$
 Konkav



BX $170/160 \times 145/145$
 Konkav



Br $170/135 \times 170/135$
 Konkav



Br $170/140 \times 170/140$
 Konkav



B $170/150 \times 170/150$
 Standard
 Konkav



BX $170/150 \times 170/150$
 Konkav

Bale shape
Forme à balle
Forma de fardo
Ballform

Ballenform



B



BX 170/150 X 170/160
Konkav



B 170/155 X 170/155
Konkav



B 173/152 X 155/132
Konkav



Br 175/155 X 135/95
Konkav



B 175/170 X 145/135
Konkav



Br 175/140 X 140/120
Konkav



B 175/180 X 155/130
Konkav



B 175/160 X 160/140
Konkav

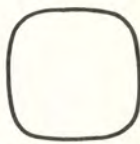

Br 175/140 X 175/140
Konkav



Br 180/165 X 140/75
Konkav



B 180/165 X 145/115
Konkav



B 180/165 X 145/135
Konkav

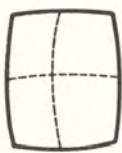

BX 180/170 X 155/130
Konkav

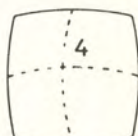

BX 180/160 X 175/160
Konkav



BX 180/160 X 180/160
Standard

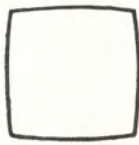

B 180/170 X 180/170
Optik
Konkav



BX 180/170 X 180/170
Konkav



Br 185/160 X 125/90
Konkav



Br 185/175 X 125/115
Standard
Optik
Konkav



Br 185/165 X 130/115
Konkav



B 185/170 X 170/145
Konkav



BX 185/170 X 185/170
Konkav



B 190/170 X 150/110
Konkav



Br 190/160 X 150/120
Konkav



STERNKREUZ

B**Ballenform**

Bale shape
Forme à balle
Forma de fardo
Balform



Br 190₁₅₀ × 155₁₁₀
 Konkav



B 190₁₇₅ × 155₁₂₀
 Konkav



Br 190₁₆₀ × 160₁₁₀
 Konkav



B 190₁₅₀ × 190₁₅₀
 Konkav



Br 190₁₅₀ × 190₁₅₀
 Konkav



B 190₁₅₅ × 190₁₅₅
 Konkav



B 195₁₈₀ × 145₁₁₀
 Konkav



Br 195₁₅₀ × 195₁₅₀
 Konkav

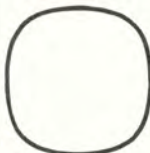

Br 197₁₅₇ × 197₁₅₇
 Konkav



B 200₁₉₅ × 135₁₁₀
 Konkav



Br 200₁₇₀ × 160₁₂₀
 Konkav



Br 200₁₇₂ × 170₁₄₅
 Konkav

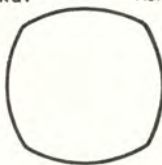

B 200₁₅₅ × 200₁₈₅
 Konkav



B 200₁₇₀ × 200₁₇₀
 Standard
 Konkav



BX 200₁₀₀ × 200₁₀₀
 Konkav



B 200₁₈₀ × 200₁₇₂
 Konkav



Br 201₁₆₅ × 198₁₆₅
 Konkav



Br 202₁₈₀ × 202₁₈₀
 Konkav



Br 204₁₆₅ × 201₁₆₅
 Konkav



B 205₉₅ × 140₁₂₀
 Konkav



Br 205₁₆₀ × 175₁₂₅
 Konkav



B 205₁₈₀ × 175₁₈₀
 Konkav

Bale shape
Forme à balle
Forma de fardo
Ballform

Ballenform



B $205/195 \times 175/160$
Konkav



BX $205/195 \times 180/165-5$
Konkav



Br210 $195 \times 150/125$
Konkav



BX $210/190 \times 190/165$
Optik

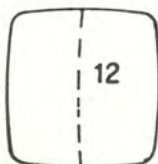

BZr $210/195 \times 205/190$
Konkav

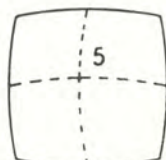

BX $210/190 \times 210/190$
Optik
Konkav

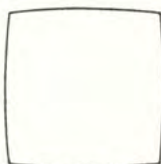

B $210/200 \times 210/200$
Optik



Br 215 $190 \times 115/090$
Konkav



Br 215 $195 \times 115/090$
Konkav



B 215 $210 \times 120/60$
Konkav



Br 215 $190 \times 135/85$
Konkav



Br 215 $195 \times 135/115$
Konkav



B $215/195 \times 180/150$
Konkav



Br $215/180 \times 190/175$
Konkav



B $215/190 \times 190/165$
Konkav

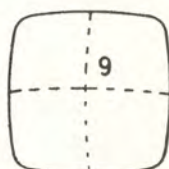

BXr $215/195 \times 215/195$
Standard
Konkav



STERNKREUZ

B**Ballenform**

Bale shape
Forme à balle
Forma de fardo
Balform



Br 220₂₀₅ x 145₁₁₅
 Konkav



Br 220₁₈₅ x 165₁₁₅
 Konkav



Br 220₁₈₀ x 175₁₂₅
 Konkav



B 220₁₈₅ x 210₁₇₈
 Standard

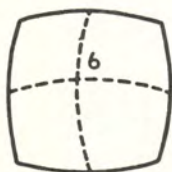

BX 220₂₀₀ x 210₂₀₀
 Konkav

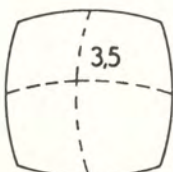

BX 220₁₉₀ x 220₁₉₀
 Optik

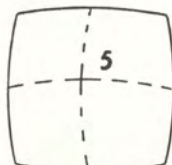

BX 220₁₉₅ x 220₁₉₅
 Konkav



B 220₁₉₅ x 220₁₉₅
 Konkav

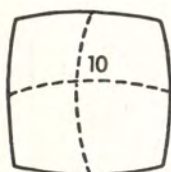

BX 220₂₀₀ x 220₂₀₀
 Konkav



BX 225₁₉₀ x 150₁₄₀₋₅
 Konkav

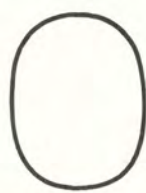

Br 225₁₆₉ x 170₁₃₀
 Konkav



B 225₂₁₅ x 200₁₈₅
 Konkav

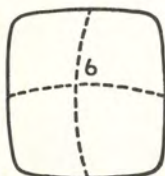

BXr 225₂₀₅ x 210₁₉₀
 Optik

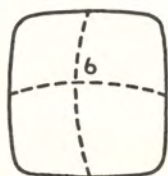

BXr 225₂₀₅ x 210₁₉₀
 Optik



BX 225₂₁₀ x 210₁₇₅
 Konkav



B 225₁₉₀ x 220₁₉₀
 Standard

Bale shape
Forme à balle
Forma de fardo
Ballform

Ballenform

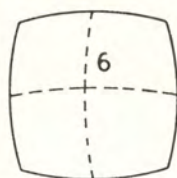
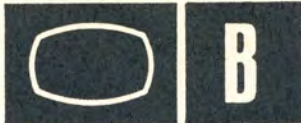

BX 225/195 X 225/195
Konkav

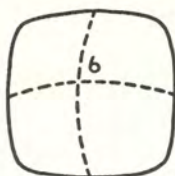

BXR 225/200 X 225/200
Konkav

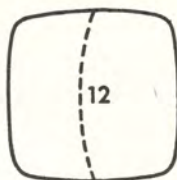

BZr 225/215 X 225/200
Standard

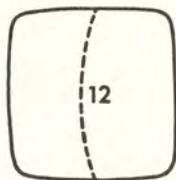

BZr 225/215 X 225/220
Standard
Optik
Konkav



BZ 220/220 X 140/110
Konkav



BZ30/215 X 145/95
Konkav



B 220/200 X 200/160
Optik



Br 220/205 X 200/155
Konkav

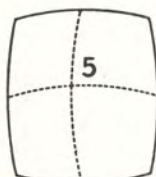

BX 220/205 X 200/180
Konkav

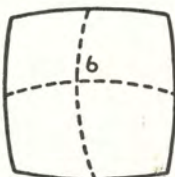

BX 220/210 X 225/210
Konkav



B 220/205 X 220/205
Konkav

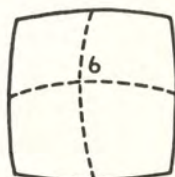

BX 220/210 X 220/210
Konkav



B 235/205 X 160/115
Konkav

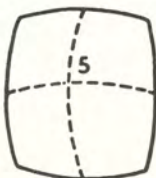

BX 225/225 X 195/180
Optik

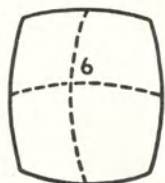

BX 225/210 X 205/175
Konkav

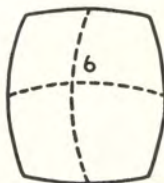

BX 225/220 X 210/170
Konkav



STERNKREUZ

B**Ballenform**

Bale shape
Forme à balle
Forma de fardo
Balform

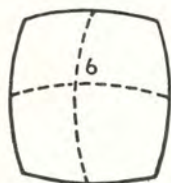

BX 235/210 X 215/180
Optik

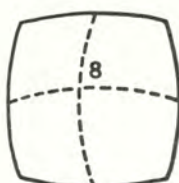

BX 235/215 X 230/200
Konkav

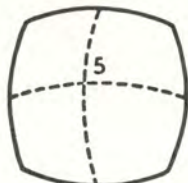

BX 235/195 X 235/190
Optik



B 240/220 X 120/100
Konkav

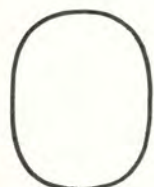

Br240/200 x 185/145
Konkav

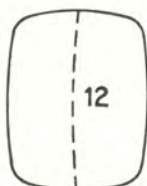

BZr 240/210 X 185/170
Optik



B 240/220 x 190/140
Konkav

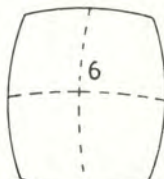

BX 240/220 X 215/170
Konkav

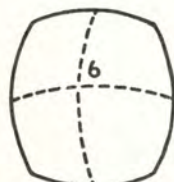

BX 240/205 X 220/170
Optik

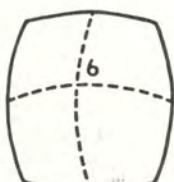

BX 240/215 X 220/175
Konkav

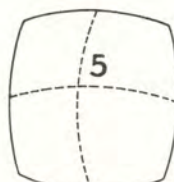

BX 240/205 X 225/195
Optik



BXr 240/220 X 225/190
Konkav



B 240/215 X 230/170
Konkav



BXr 240/215 X 230/210
Konkav

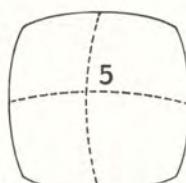

BX 240/200 X 240/200
Konkav

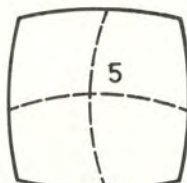

BX 240/215 X 240/215
Konkav

Bale shape
Forme à balle
Forma de fardo
Balform

Ballenform



B 245/230 x 165/140
Konkav

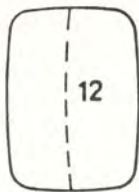

BZr 245/230 x 175/168
Optik

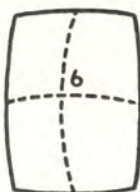

BX 245/235 x 180/145
Standard

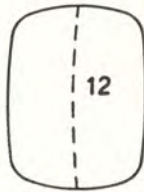

BZr 245/205 x 165/178
Konkav



B 245/205 x 165/170
Konkav

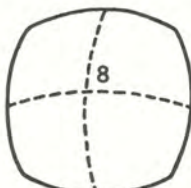

BX 245/195 x 245/198
Optik

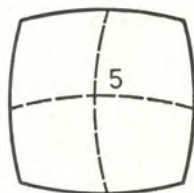

BX 245/215 x 245/215
Konkav



Br 250/210 x 145/100
Konkav

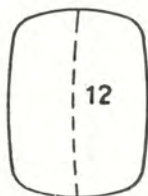

BZr 250/210 x 185/178
Standard
Konkav



B 250/235 x 240/210
Konkav



Br 250/230 x 200/175
Konkav



Br 250/200 x 220/180
Konkav



B 250/225 x 250/225
Konkav

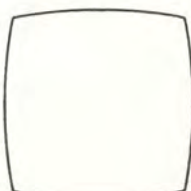

B 250/230 x 250/230
Konkav



Br 255/210 x 205/140
Konkav



BXr 255/230 x 235/200
Konkav



STERNKREUZ



Ballenform

Bale shape
Forme à balle
Forma de fardo
Balform

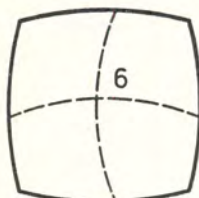

BX $255/225 \times 255/225$
Konkav



B $255/225 \times 255/225$
Konkav



B $255/230 \times 255/230$
Konkav

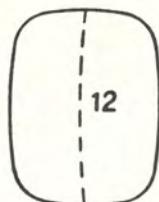

BZr $260/235 \times 260/175$
Standard
Konkav



B $260/235 \times 220/180$
Standard

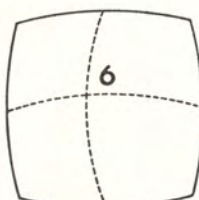

BX $260/230 \times 260/230$
Konkav

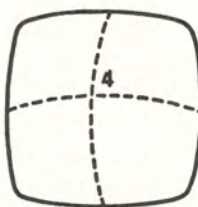

BXr $260/230 \times 260/230$
Standard
Konkav

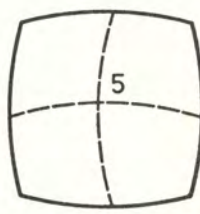

BX $260/230 \times 260/230$
Konkav



B $265/240 \times 230/160$
Konkav



B $265/250 \times 240/220$
Konkav

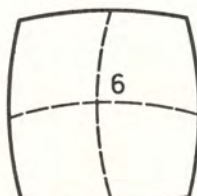

BX $265/240 \times 265/225$
Konkav



B $265/240 \times 265/225$
Konkav



BX $265/240 \times 265/240$
Konkav



Br $269/220 \times 269/220$
Konkav



B $270/250 \times 135/1095$
Konkav



B $270/255 \times 225/215$
Konkav

Bale shape
 Forme à balle
 Forma de fardo
 Balform

Ballenform



B



Br 270/235 x 240/200
 Konkav



B 270/250 x 240/205
 Konkav



BX 270/290 x 240/205
 Konkav



Br 275/265 x 125/95
 Konkav



BZ 275/255 x 145/105
 Konkav



Br 275/255 x 245/225
 Konkav



Br 275/210 x 250/190
 Konkav

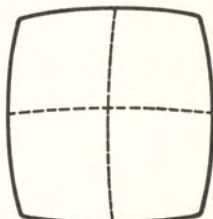

BX 275/255 x 260/235
 Konkav

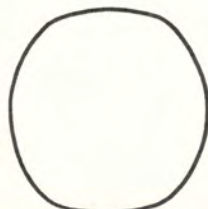

Br 275/240 x 245/170
 Konkav



Br 275/230 x 275/230
 Konkav

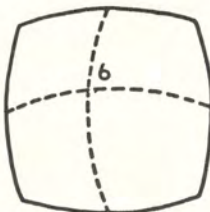

BX 275/240 x 275/240
 Konkav



B 278/223 x 278/223
 Konkav



STERNKREUZ

B**Ballenform**

Bale shape
Forme à balle
Forma de fardo
Balform



Br 280/240 x 200/165
Konkav



B 280/255 x 200/165
Konkav

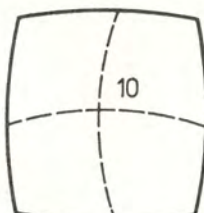

BX 280/260 x 265/235
Konkav

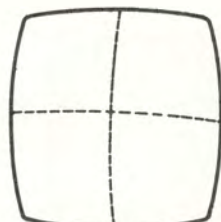

BX 280/260 x 265/248
Konkav

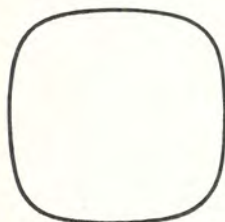

Br 280/220 x 280/220
Konkav



Br 280/240 x 280/248
Konkav

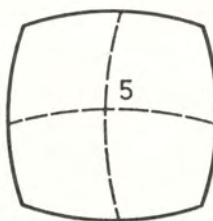

BX 280/240 x 280/240 -5
Konkav

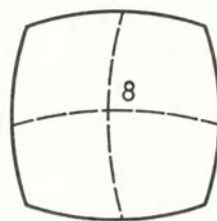

BX 280/240 x 280/240 -8
Konkav

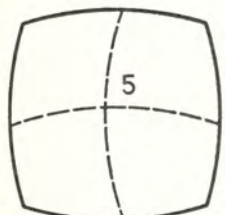

Br 280/245 x 280/245
Konkav



B 280/250 x 280/250
Konkav

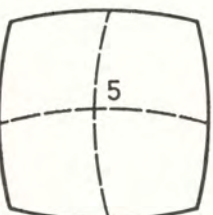

BX 280/250 x 280/250
Konkav

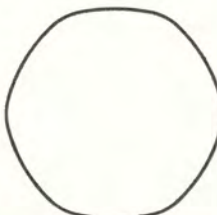

Br 280/225 x 290/140
Konkav

Bale shape
 Forme à balle
 Forma de fardo
 Balform

Ballenform



Br 285/265 x 150/110
 Konkav



B 285/275 x 195/175
 Konkav

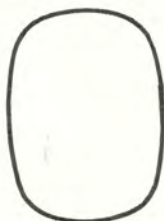

Br 285/250 x 205/175
 Konkav

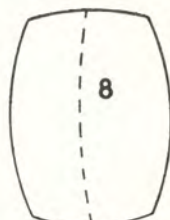

BZ 285/260 x 215/160
 Standard



Br 285/245 x 245/195
 Konkav

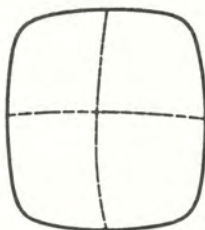

B X r 285/235 x 250/200 - 8
 Konkav



B 285/240 x 265/210
 Konkav

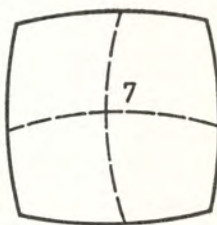

BX 285/255 x 285/255
 Konkav



Br 287/250 x 262/217
 Konkav



Bs 290/245 x 200/175
 Konkav



Br 290/260 x 220/180
 Konkav

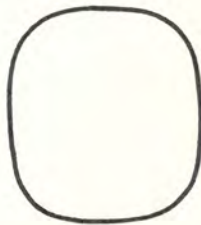

Br 290/230 x 260/190
 Konkav



STERNKREUZ

B**Ballenform**

Bale shape
Forme à balle
Forma de fardo
Balform

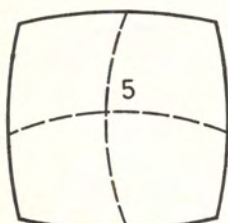

BX $290/290 \times 290/260$
 Konkav



Br $290/270 \times 290/270$
 Konkav



Bs $292/277 \times 240/216$
 Konkav



Br $295/275 \times 160/130$
 Konkav



Br $295/250 \times 295/250$
 Konkav



Br $300/255 \times 225/145$
 Konkav



Br $300/250 \times 230/145$
 Konkav



Br $300/265 \times 255/195$
 Konkav



Br $300/260 \times 260/220$
 Konkav



B $302/287 \times 218/185$
 Konkav



Br $304/260 \times 304/260$
 Konkav

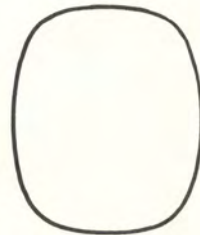

Br $305/260 \times 250/180$
 Konkav

Bale shape
Forme à balle
Forma de fardo
Ballform

Ballenform

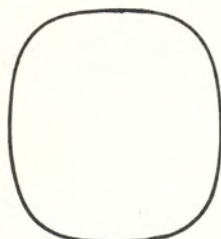
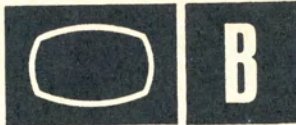

Br 205/245 x 270/210
Konkav



Br 305/260 x 300/245
Konkav



Br 315/280 x 265/195
Konkav

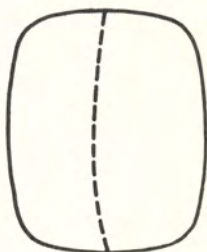

BZr 325/315 x 265/255
Konkav

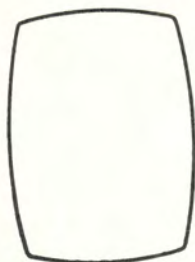

B 320/305 x 240/205
Konkav



Br 335/295 x 205/135
Konkav

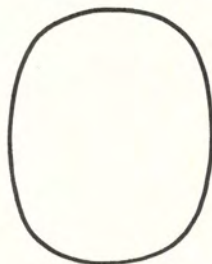

Br 340/280 x 275/200
Konkav



Br 395/375 x 150/85
Konkav



Supplement

L Series

Laternenform

Lantern shape

Forme à Lanterne

Forma de Linterna

Lyktform

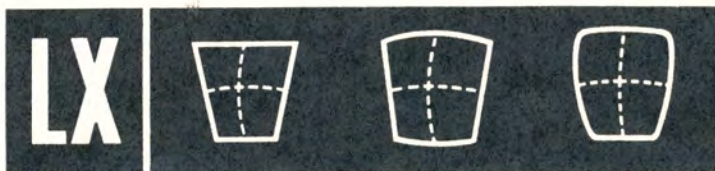



Laternenform

Lantern shape
 Forme à Lanterne
 Forme de Linterna
 Lyktform

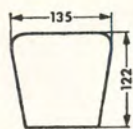

L 122 x 135.1
 Konkav

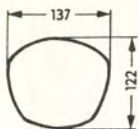

L 122 x 137 1
 Konkav

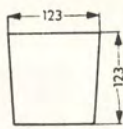

L 123 x 123 1
 Konkav

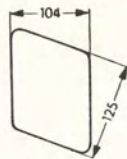

Ly 125 x 104 1
 Konkav

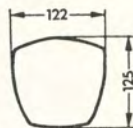

L 125 x 122 . 1
 Konkav

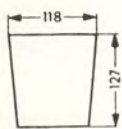

L 127 x 118 1
 Konkav

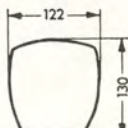

L 130 x 122 1
 Konkav

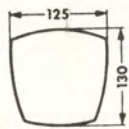

L 130 x 125.1
 Konkav

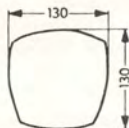

L 130 x 130 1
 Konkav

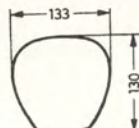

L 130 x 133 1
 Konkav

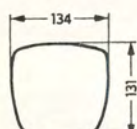

L 131 x 134 1
 Konkav

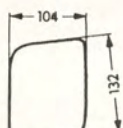

Ly 132 x 104 . 1
 Konkav

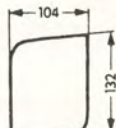

Ly 132 x 104 2
 Konkav

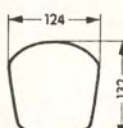

L 132 x 124 1
 Konkav

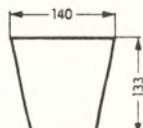

L 133 x 140 1
 Konkav

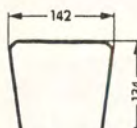

L 134 x 142 9
 Konkav

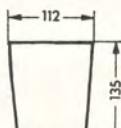

L 135 x 112 1
 Konkav

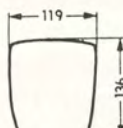

L 136 x 119 1
 Konkav

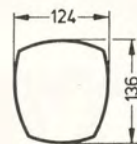

L 136 x 124 1
 Konkav

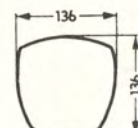

L 136 x 136 1
 Konkav

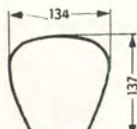

L 137 x 134 1
 Konkav

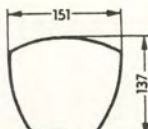

L 137 x 151 1
 Konkav

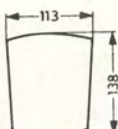

L 138 x 113 1
 Konkav

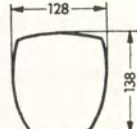

L 138 x 128 1
 Konkav

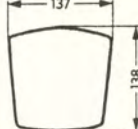

L 138 x 137 1
 Konkav

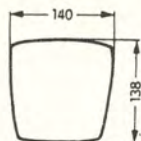

L 138 x 140 . 1
 Konkav

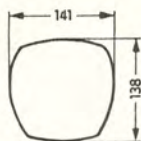

L 138 x 141 . 1
 Konkav

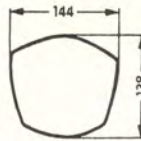

L 138 x 144 . 9
 Konkav

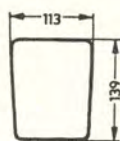

L 139 x 113 . 1
 Konkav

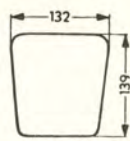

L 139 x 132 . 1
 Konkav

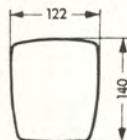

L 140 x 122 . 1
 Konkav

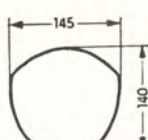

L 140 x 145 . 1
 Konkav

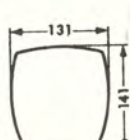

L 141 x 131.1
 Konkav

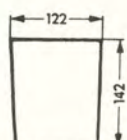

L 142 x 122 . 1
 Konkav

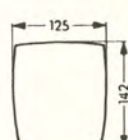

L 142 x 125 . 1
 Konkav

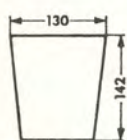

L 142 x 130.1
 Konkav

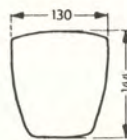

L 144 x 130 . 1
 Konkav

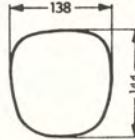

L 144 x 138 . 2
 Konkav

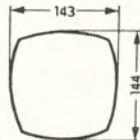

L 144 x 143 . 1
 Konkav

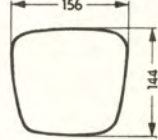

L 144 x 156 . 1
 Konkav

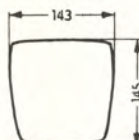

L 145 x 143 . 1
 Konkav

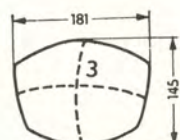

LX 145 x 181 . 1
 Konkav

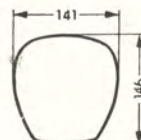

L 146 x 141 . 1
 Konkav



LX 146 x 142 . 1
 Konkav

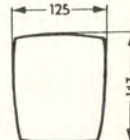

L 147 x 125 . 1
 Konkav

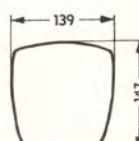

L 147 x 139 . 1
 Konkav

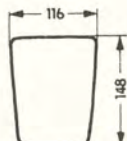

L 148 x 116 . 1
 Konkav

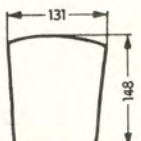

L 148 x 131 . 1
 Konkav

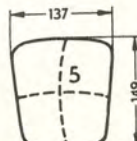

LX 149 x 137 . 1
 Konkav

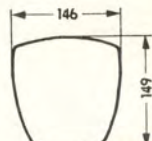

L 149 x 146 . 1
 Konkav

L



Laternenform

Lantern shape
Forme à Lanterne
Forma de Linterna
Lyktform

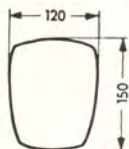

L 150 x 120 . 1
Konkav

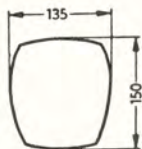

L 150 x 135 . 1
Konkav

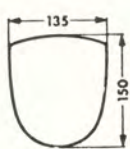

L 150 x 135.2
Konkav

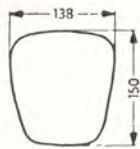

L 150 x 138 . 1
Konkav

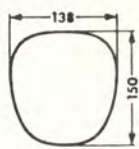

L 150 x 138.2
Konkav

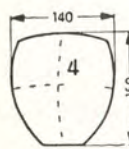

LX 150 x 140 . 1
Konkav

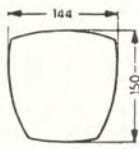

L 150 x 144 . 1
Konkav

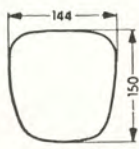

L 150 x 144 . 2
Konkav

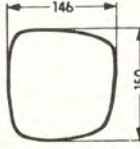

Ly 150 x 146 . 1
Konkav

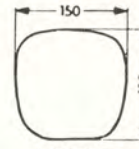

L 150 x 150 . 1
Konkav

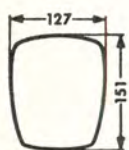

L 151 x 127.1
Konkav

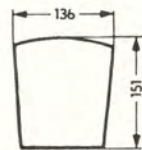

L 151 x 136 . 1
Konkav

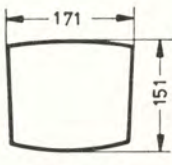

L 151 x 171.1
Konkav

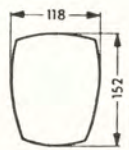

L 152 x 118 . 1
Konkav

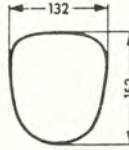

L 152 x 132 . 1
Konkav

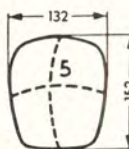

LX 152 x 132 . 1
Konkav

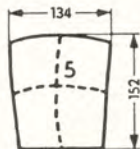

LX 152 x 134 . 1
Konkav

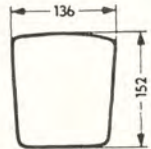

L 152 x 136 . 1
Konkav

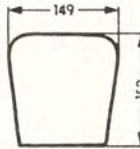

L 152 x 149 . 1
Konkav

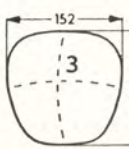

LX 152 x 152 . 1
Konkav

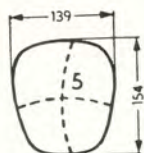

LX 154 x 139 . 1

Konkav

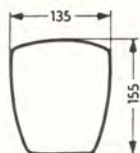

L 155 x 135 . 1

Konkav

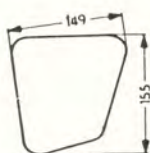

Ly 155 x 149 . 1

Konkav

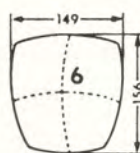

LX 156 x 149 . 1

Konkav

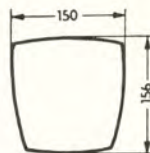

L 156 x 150 . 1

Konkav

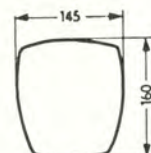

L 160 x 145 . 1

Konkav

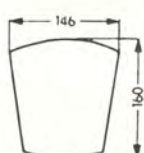

L 160 x 146 . 1

Konkav

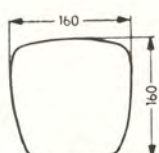

L 160 x 160 . 1

Konkav

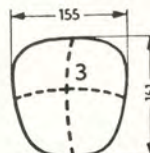

LX 161 x 155 . 1

Konkav

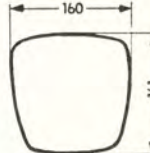

L 161 x 160 . 1

Konkav

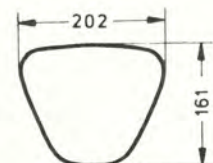

L 161 x 202 . 1

Konkav

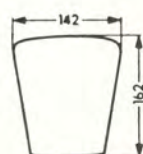

L 162 x 142 . 1

Konkav

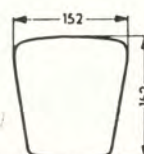

L 162 x 152 . 1

Konkav

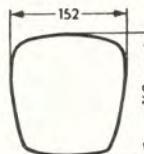

L 162 x 152 . 2

Konkav

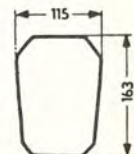

L 163 x 115 . 1

Konkav

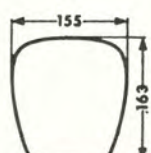

L 163 x 155 . 1

Konkav

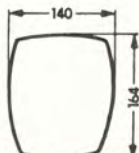

L 164 x 140 . 1

Konkav

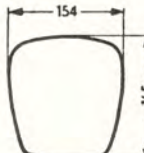

L 165 x 154 . 1

Konkav

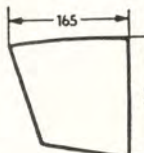

Ly 165 x 165 . 1

Konkav

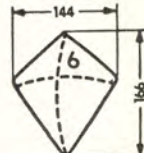

LX 166 x 144 . 1

Konkav



Laternenform

Lantern shape
Forme à Lanterne
Forma de Linterna
Lyktform

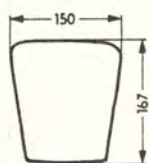

L 167 x 150 . 1
Konkav

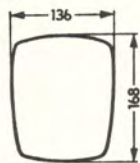

L 168 x 136 . 1
Konkav

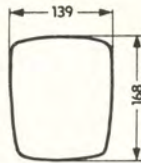

L 168 x 139 . 1
Konkav

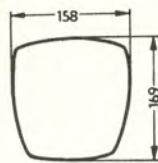

L 169 x 158 . 1
Konkav

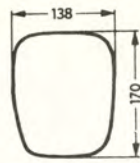

L 170 x 138 . 1
Konkav

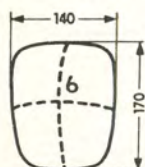

LX 170 x 140 . 1
Konkav

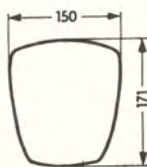

L 171 x 150 . 1
Konkav

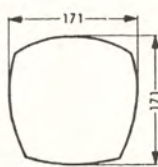

L 171 x 171 . 1
Konkav

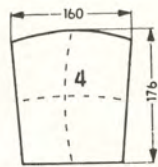

LX 176 x 160 . 1
Konkav

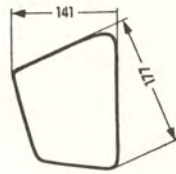

Ly 177 x 141 . 1
Konkav

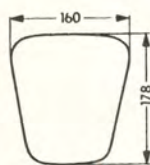

L 178 x 160 . 1
Konkav

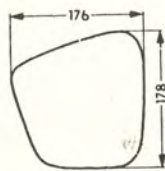

Ly 178 x 176 . 1
Konkav

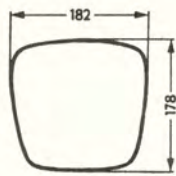

L 178 x 182 . 9
Konkav

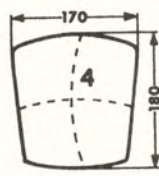

LX 180 x 170 . 1
Konkav

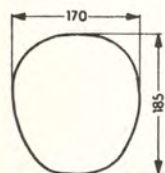

L 185 x 170 . 1
Konkav

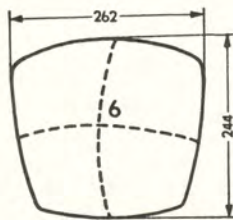

LX 244 x 262 . 1
Konkav

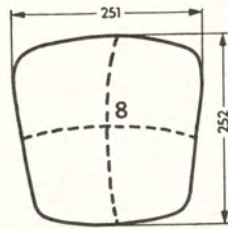

LX 252 x 251 . 1
Konkav

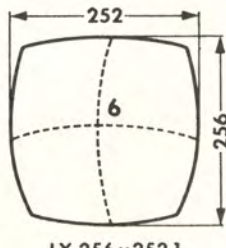

LX 256 x 252 . 1
Konkav

SEIKO
253 x 180
ESONO9AN

Lantern shape
Forme à Lanterne
Forma de Linterna
Lyktform

Laternenform



L

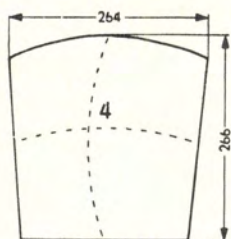

LX 266 x 264.1
Konkav

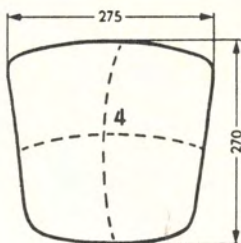

LX 270 x 275.1
Konkav

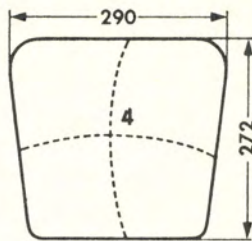

LX 272 x 290.1
Konkav

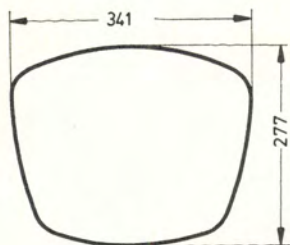

L 277 x 341.1
Konkav

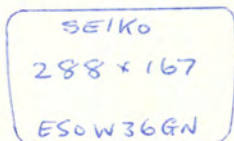

STERNKREUZ

Ellipsenform

Elliptical shape

Forme elliptique

Eliptico

Ellipsform

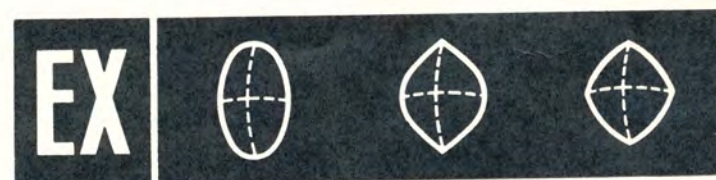
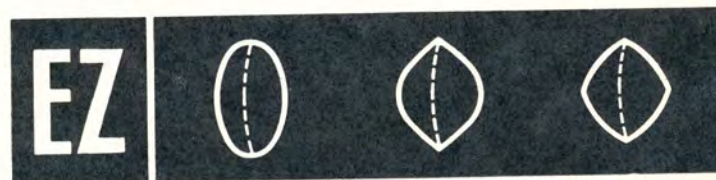

E

E

O

Ellipsenform

Elliptical shape
Forme elliptique
Elíptico
Ellipsform



E 112 x 80.1
Konkav

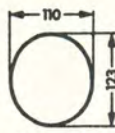

E 123 x 110.1
Konkav

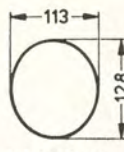

E 128 x 113.1
Konkav

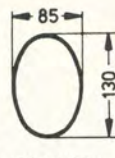

E 130 x 85.1
Konkav

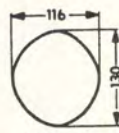

E 130 x 116.1
Konkav

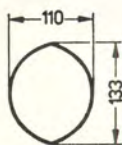

E 133 x 110.1
Konkav

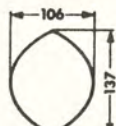

E 137 x 106.1
Konkav

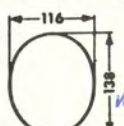

E 138 x 116.1
Konkav

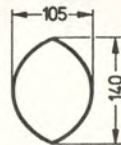

E 140 x 105.1
Konkav

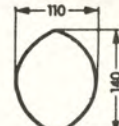

E 140 x 110.1
Konkav

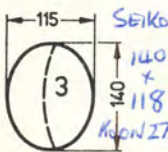

EZ 140 x 115.1
Konkav

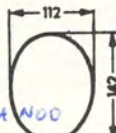

E 142 x 112.1
Konkav

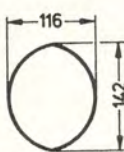

E 142 x 116.1
Konkav

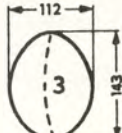

EZ 143 x 112.1
Konkav

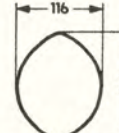

E 143 x 116.1
Konkav

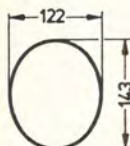

E 143 x 122.1
Konkav

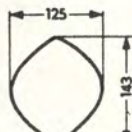

Ey 143 x 125.1
Konkav

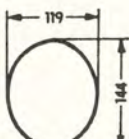

E 144 x 119.1
Konkav

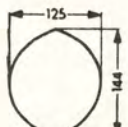

E 144 x 125.1
Konkav

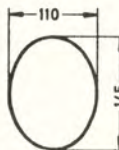

E 145 x 110.1
Konkav

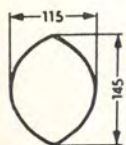

E 145 x 115.1
Konkav

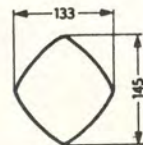

E 145 x 133.1
Konkav

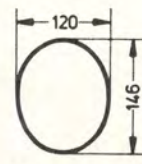

E 146 x 120.1
Konkav

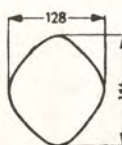

E 146 x 128.1
Konkav

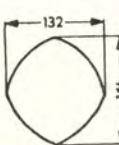

E 146 x 132.1
Konkav

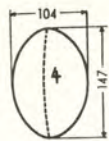

EZ 147 x 104 . 1
Konkav

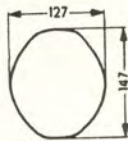

E 147 x 127 . 1
Konkav

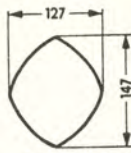

E 147 x 127 . 2
Konkav

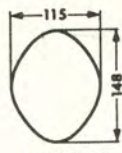

E 148 x 115.1
Konkav

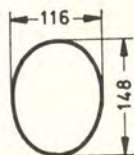

E 148 x 116.1
Konkav

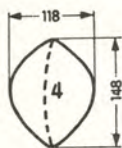

EZ 148 x 118 . 1
Konkav

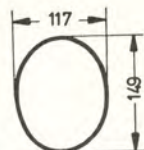

E 149 x 117 . 1
Konkav

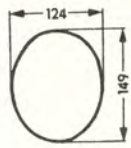

E 149 x 124 . 1
Konkav

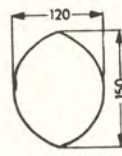

E 150 x 120 . 1
Konkav

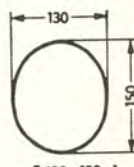

E 150 x 130 . 1
Konkav

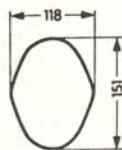

E 151, x 118 . 1
Konkav

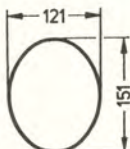

E 151 x 121.1
Konkav

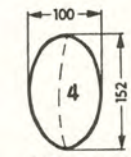

EZ 152 x 100 . 1
* Konkav

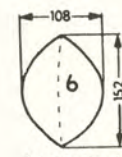

EZ 152 x 108 . 1
Konkav

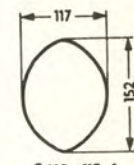

E 152 x 117 . 1
Konkav

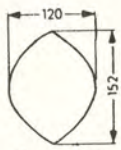

E 152 x 120 . 1
Konkav

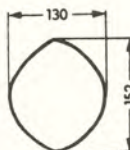

E 152 x 130 . 1
Konkav

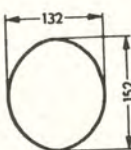

E 152 x 132 . 1
Konkav

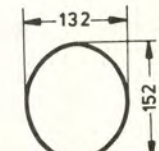

E 152 x 132.2
Konkav

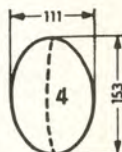

EZ 153 x 111 . 1
Konkav

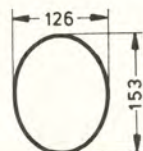

E 153 x 126.1
Konkav

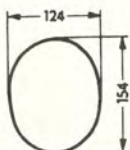

E 154 x 124 . 1
Konkav

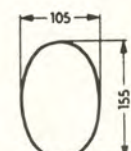

E 155 x 105 . 1
Konkav

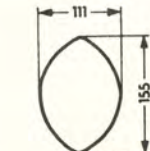

E 155 x 111 . 1
Konkav

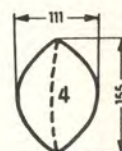

EZ 155 x 111 . 2
Konkav

E O

Ellipsenform

Elliptical shape
Forme elliptique
Elíptico
Ellipsform

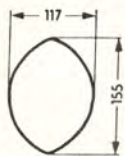

E 155 x 117 . 1
Konkav

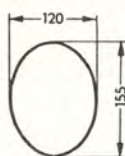

E 155 x 120 . 1
Standard

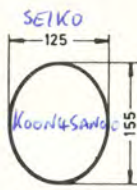

E 155 x 125.1
Konkav

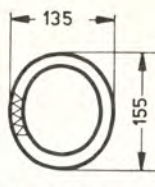

ECP 155 x 135.1
Konkav

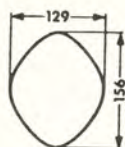

E 156 x 129.1
Konkav

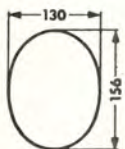

E 156 x 130.1
Konkav

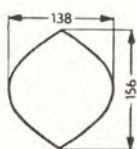

E 156 x 138 . 1
Konkav

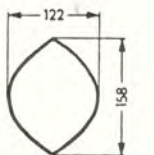

E 158 x 122 . 1
Konkav

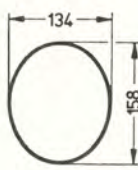

E 158 x 134.1
Konkav

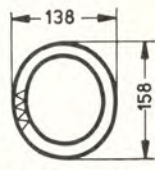

ECP 158 x 138 . 1
Konkav

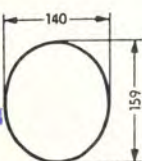

E 159 x 140 . 1
Konkav

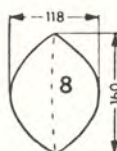

EZ 160 x 118 . 1
Konkav

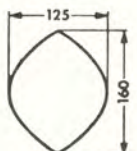

E 160 x 125.1
Konkav

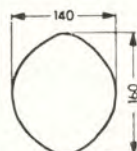

E 160 x 140 . 1
Konkav



E161 x 92.1
Konkav

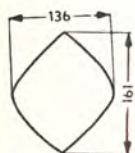

Ey 161 x 136 . 1
Konkav

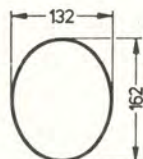

E 162 x 132.1
Konkav

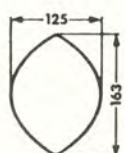

E 163 x 125.1
Konkav

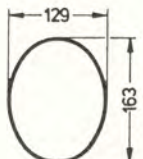

E 163 x 129.1
Konkav

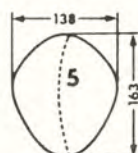

EZ 163 x 138.1
Konkav

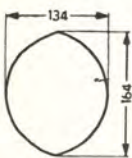

E 164 x 134 . 1
Konkav

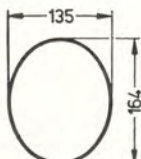

E 164 x 135.1
Konkav

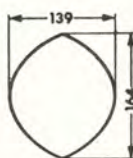

E 164 x 139.1
Konkav

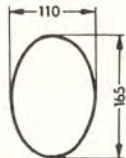

E 165 x 110 . 1
Standard

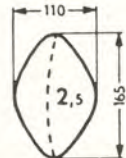

EZ 165 x 110 . 1
Konkav

Elliptical shape
Forme elliptique
Elíptico
Ellipsform

Ellipsenform



E



EZ 165 x 133.1

Konkav

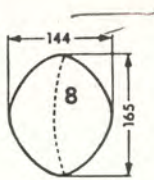

EZ 165 x 144.1

Konkav

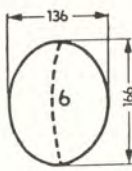

EZ 166 x 136.1

Konkav

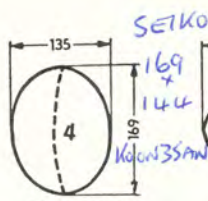

EZ 169 x 135.1

Konkav

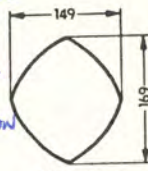

E 169 x 149.1

Konkav

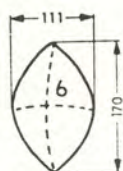

EX 170 x 111.1

Konkav

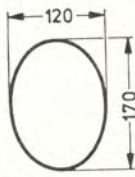

E 170 x 120.1

Konkav

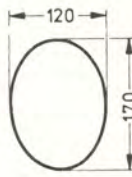

E 170 x 120.1

Standard

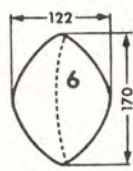

EZ 170 x 122.1

Konkav

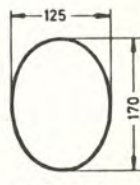

E 170 x 125.1

Konkav

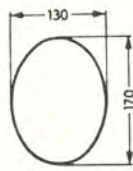

E 170 x 130.1

Konkav

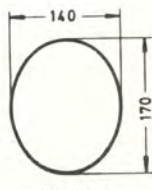

E 170 x 140.1

Konkav

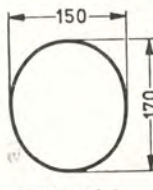

E 170 x 150.1

Konkav

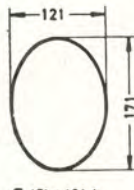

E 171 x 121.1

Konkav

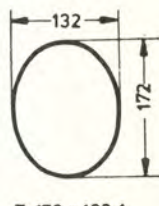

E 172 x 132.1

Konkav

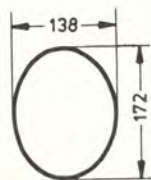

E 172 x 138.1

Konkav

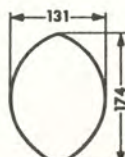

E 174 x 131.1

Konkav

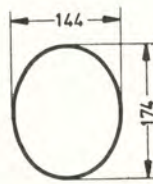

E 174 x 144.1

Konkav

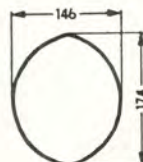

E 174 x 146.1

Konkav

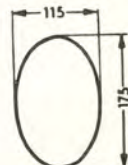

E 175 x 115.1

Standard



STERNKREUZ

E

O

Ellipsenform

Elliptical shape
Forme elliptique
Elíptico
Ellipsform

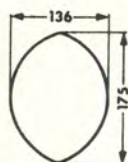

E 175 x 136.1
Konkav

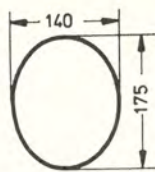

E 175 x 140.1
Konkav

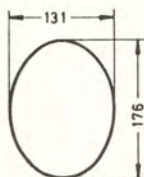

E 176 x 131.1
Konkav

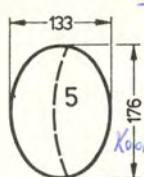

EZ 176 x 133.1
Konkav

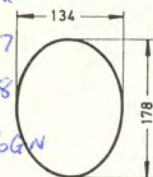

E 178 x 134.1
Konkav

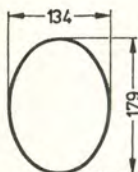

E 179 x 134.1
Konkav

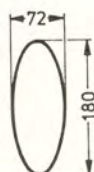

E 180 x 72.1
Konkav

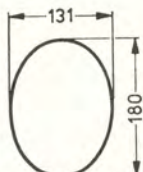

E 180 x 131.1
Konkav

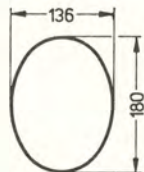

E 180 x 136.1
Konkav

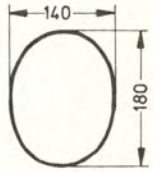

E 180 x 140.1
Konkav

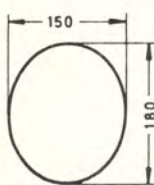

E 180 x 150.1
Konkav

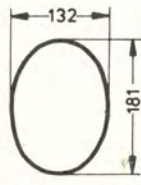

E 181 x 132.1
Konkav

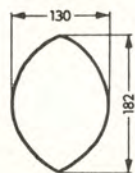

E 182 x 130.1
Konkav

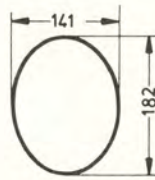

E 182 x 141.1
Konkav

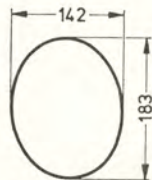

E 183 x 142.1
Konkav

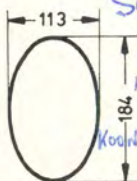

E 184 x 113.1
Konkav



E 184 x 144.1
Konkav

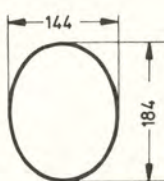

E 184 x 144.2
Konkav

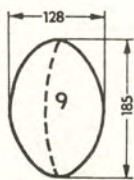

EZ 185 x 128.1
Konkav

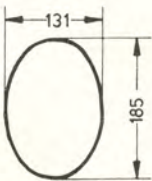

E 185 x 131.1
Konkav

Elliptical shape
Forme elliptique
Elíptico
Ellipsform

Ellipsenform

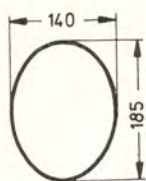

E 185 x 140 1
Konkav

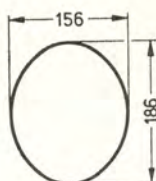

E 186 x 156.1
Konkav

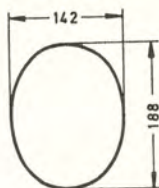

E 188 x 142 1
Konkav

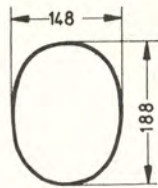

E 188 x 148.1
Konkav

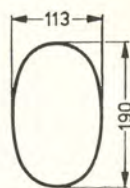

E 190 x 113.1
Konkav

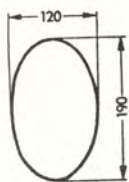

E 190 x 120.1
Standard

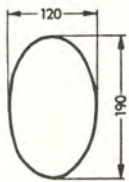

E 190 x 120.2
Konkav

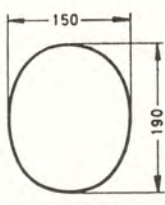

E 190 x 150 1
Konkav

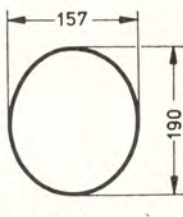

E 190 x 157 1
Konkav

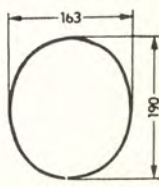

E 190 x 163 1
Konkav

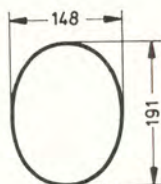

E 191 x 148 1
Konkav

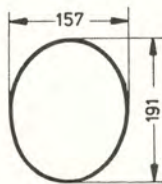

E 191 x 157.1
Konkav

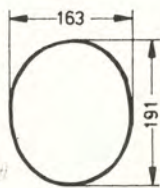

E 191 x 163.1
Konkav

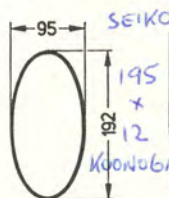

E 192 x 95.1
Konkav

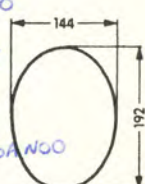

E 192 x 144 1
Konkav

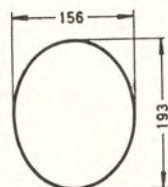

E 193 x 156.1
Konkav

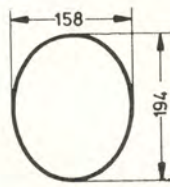

E 194 x 158.1
Konkav

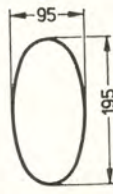

E 195 x 95.1
Konkav

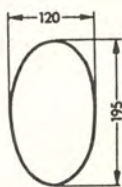

E 195 x 120 1
Standard

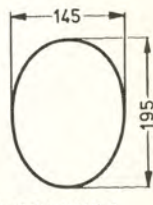

EZ 195 x 145 1
Konkav

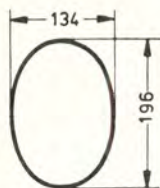
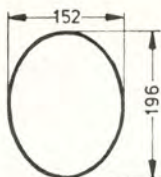
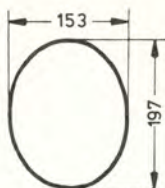
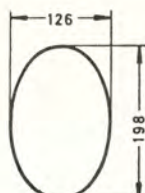
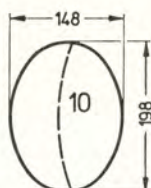
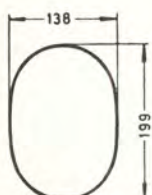
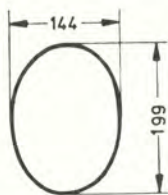
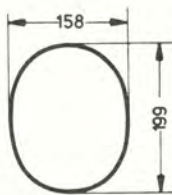
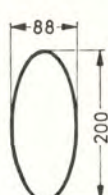
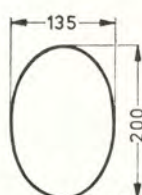
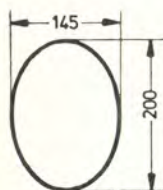
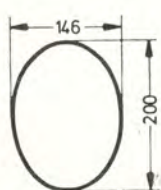
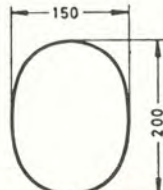
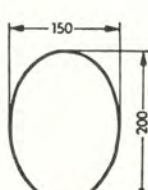
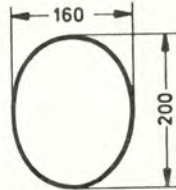
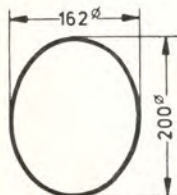
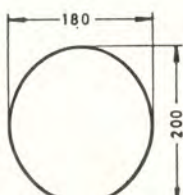
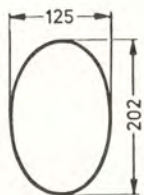
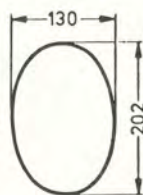
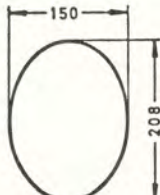

STERNKREUZ

E**O****Ellipsenform****Elliptical shape
Forme elliptique
Elíptico
Ellipsform****E 196 x 134.1
Konkav****E 196 x 152.1
Konkav****E 197 x 153.1
Konkav****E 198 x 126.1
Konkav****EZ 198 x 148.1
Konkav****EZ 199 x 138.120
Konkav****E 199 x 144.1
Konkav****E 199 x 158.2
Konkav****E 200 x 88.1
Konkav****E 200 x 135.1
Konkav****E 200 x 145.1
Konkav****E 200 x 146.1
Konkav****E 200 x 150.1
Konkav****E 200 x 150.1
Standard
Konkav****E 200 x 160.1
Konkav****E 200 x 162.1
Konkav****E 200 x 180.1
Konkav****E 202 x 125.1
Konkav****E 202 x 130.1
Konkav****E 208 x 150.1
Konkav**

Elliptical shape
Forme elliptique
Elíptico
Ellipsform

Ellipsenform

O

E

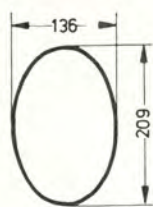

E 209 x 136.1
Konkav

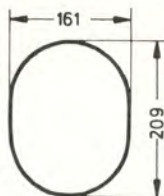

E 209 x 161.1
Konkav

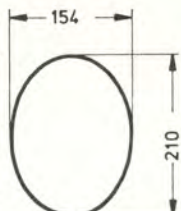

E 210 x 154.1
Konkav

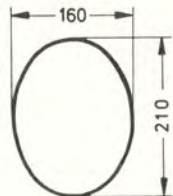

E 210 x 160.1
Konkav

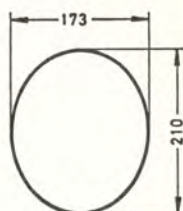

E 210 x 173.1
Konkav

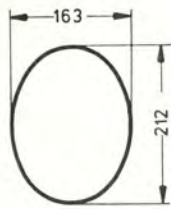

E 212 x 163.1
Konkav

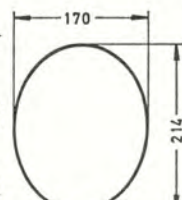

E 214 x 170.1
Konkav

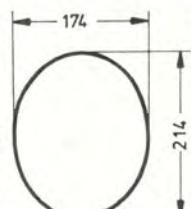

E 214 x 174.1
Konkav

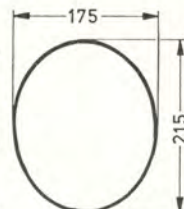

E 215 x 175.1
Konkav

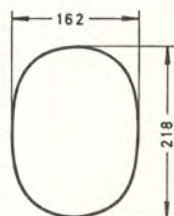

E 218 x 162.1
Konkav

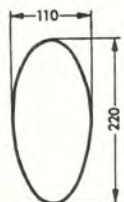

E 220 x 110.1
Standard

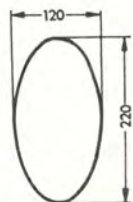

E 220 x 120.1
Standard

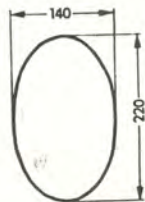

E 220 x 140.1
Standard

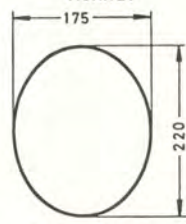

E 220 x 175.1
Konkav

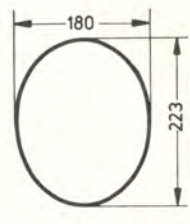

E 223 x 180.1
Konkav

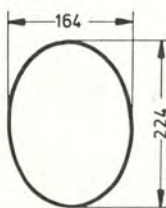

E 224 x 164.1
Konkav

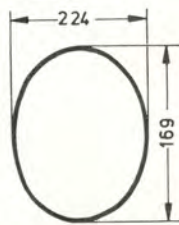

E 224 x 169.1
Konkav



E 225 x 130.1
Standard

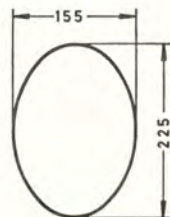

E 225 x 155.1
Konkav

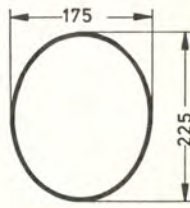

E 225 x 175.1
Konkav



STERNKREUZ

E

Ellipsenform

Elliptical shape
Forme elliptique
Eliptico
Ellipsform

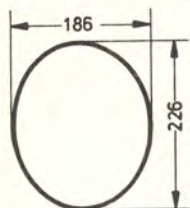

E 226 x 186.1
Konkav

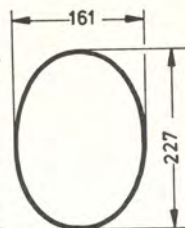

E 227 x 161.1
Konkav

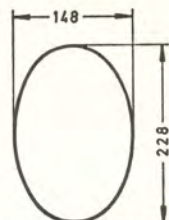

E 228 x 148.1
Konkav

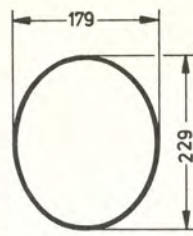

E 229 x 179.1
Konkav

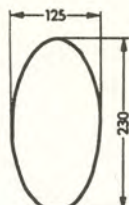

E 230 x 125.1
Standard

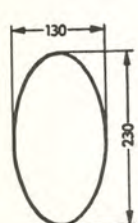

E 230 x 130.1
Standard

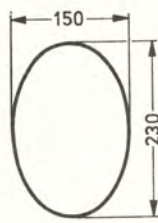

E 230 x 150.1
Konkav

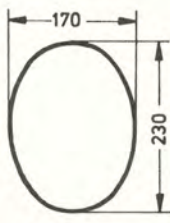

E 230 x 170.1
Konkav

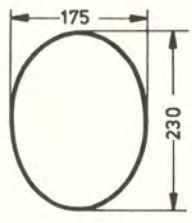

E 230 x 175.1
Konkav

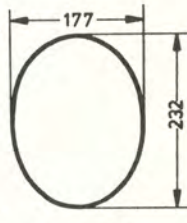

E 232 x 177.1
Konkav

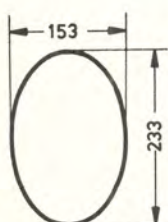

E 233 x 153.1
Konkav

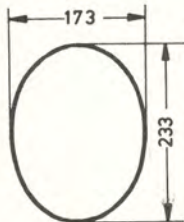

E 233 x 173.1
Konkav

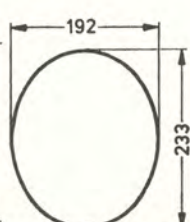

E 233 x 192.1
Konkav

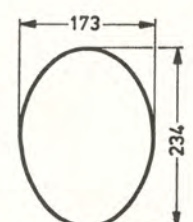

E 234 x 173.1
Konkav

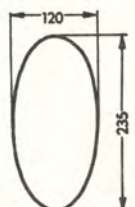

E 235 x 120.1
Standard

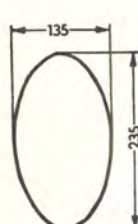

E 235 x 135.1
Standard

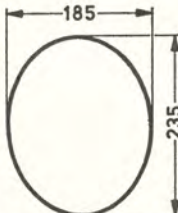

E 235 x 185.1
Konkav

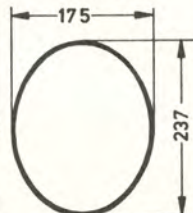

E 237 x 175.1
Konkav

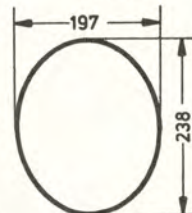

E 238 x 197.1
Konkav

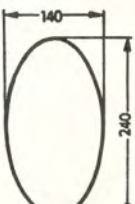

E 240 x 140.1
Standard

Elliptical shape
Forme elliptique
Elíptico
Ellipsform

Ellipsenform



E

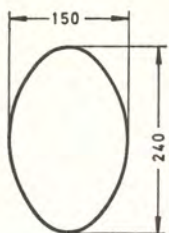

E 240 x 150 . 1
Konkav

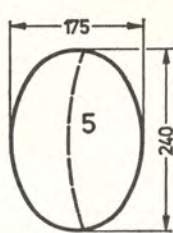

EZ 240 x 175 . 1
Konkav

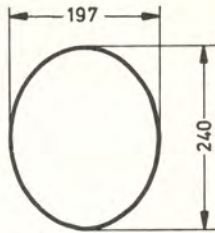

E 240 x 197 . 1
Konkav

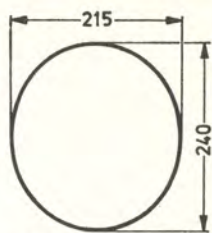

E 240 x 215 . 1
Konkav

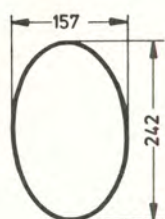

E 242 x 157 . 1
Konkav

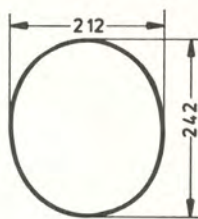

E 242 x 212 . 1
Konkav

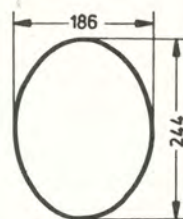

E 244 x 186 . 1
Konkav

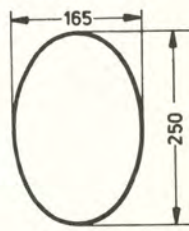

E 250 x 165 . 1
Konkav

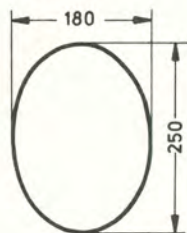

E 250 x 180 . 1
Konkav

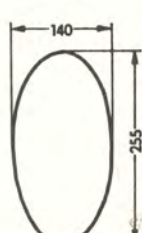

E 255 x 140 . 1
Standard



E 255 x 160 . 1
Konkav

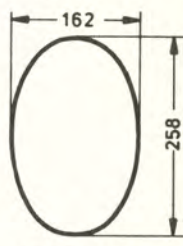

E 258 x 162 . 1
Konkav

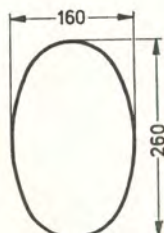

E 260 x 160 . 1
Standard Konkav

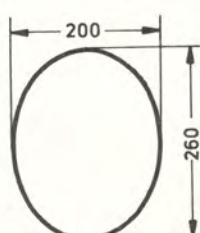

E 260 x 200 . 1
Standard

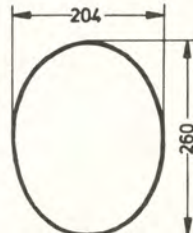

E 260 x 204 . 1
Konkav

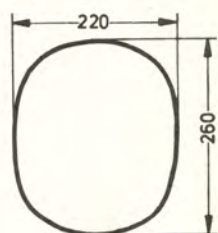

E 260 x 220 . 1
Konkav



STERNKREUZ

E**O**

Ellipsenform

Elliptical shape
 Forme elliptique
 Eliptico
 Ellipsform

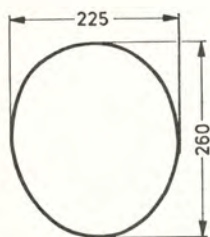

E 260 x 225.1
 Standard

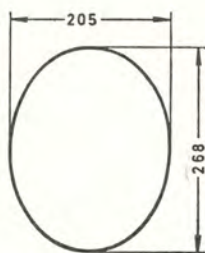

E 268 x 205 . 1
 Konkav

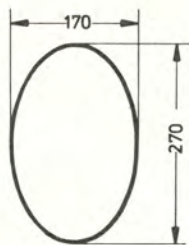

E 270 x 170.1
 Konkav

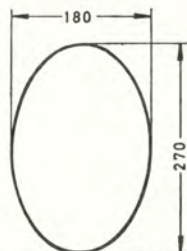

E 270 x 180 . 1
 Konkav

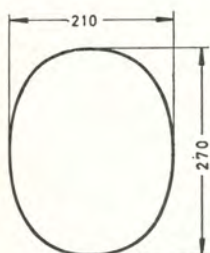

E 270 x 210 . 1
 Konkav

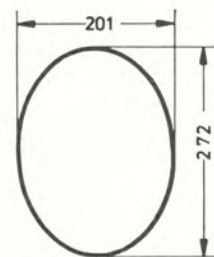

E 272 x 201.1
 Konkav

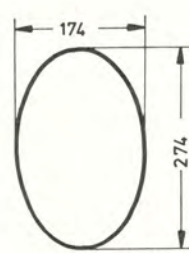

E 274 x 174.1
 Konkav

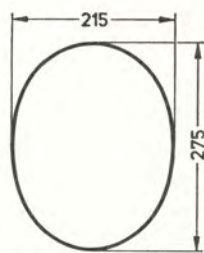

E 275 x 215.1
 Konkav

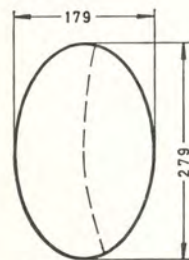

EZ 279 x 179 . 8
 Konkav

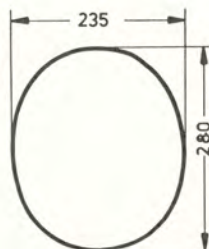

E 280 x 235.1
 Konkav

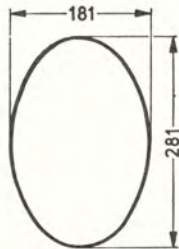

E 281 x 181.1
 Konkav

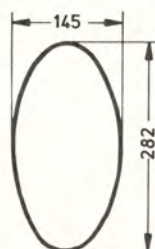

E 282 x 145.1
 Konkav

Elliptical shape
Forme elliptique
Elíptico
Ellipsform

Ellipsenform

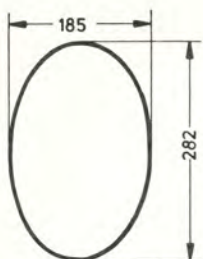

E 282x185.1
Konkav

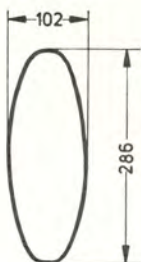

E 286 x 102.1
Konkav

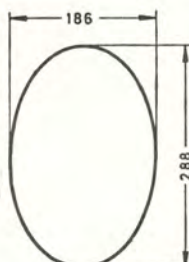

E 288 x 186 . 1
Konkav

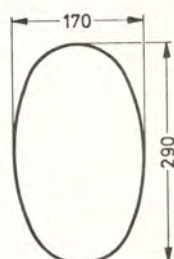

E 290x170.1
Standard

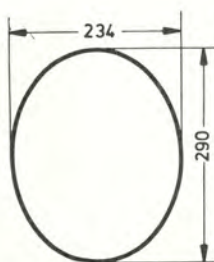

E 290 x 234.1
Konkav

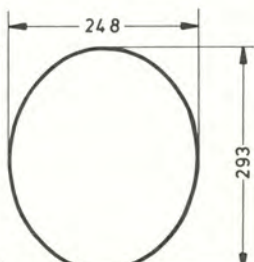

E 293 x 248.1
Konkav

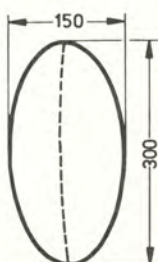

EZ 300x150.1
Konkav

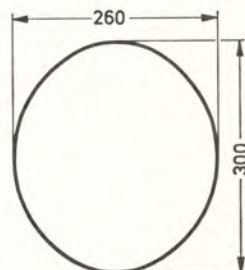

E300x260.1
Standard

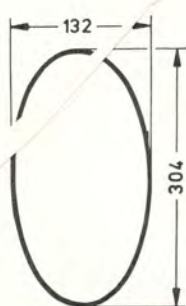

E 304x132.1
Konkav

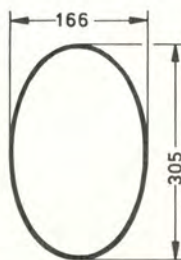

E 305x166.1
Konkav

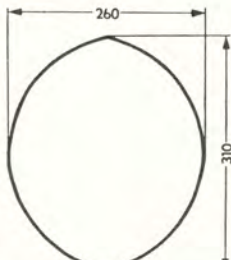

E 310 x 260 . 1
Konkav

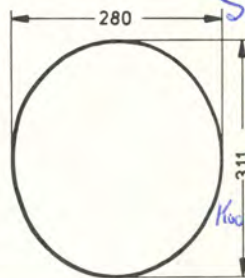

E 311 x 280
Konkav



STERNKREUZ

E

Ellipsenform

Elliptical shape
Forme elliptique
Elíptico
Ellipsform

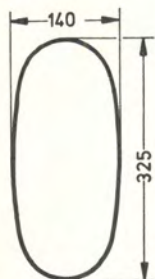

EZ 325x140.1
Konkav

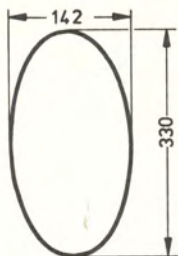

E 330x142.1
Konkav

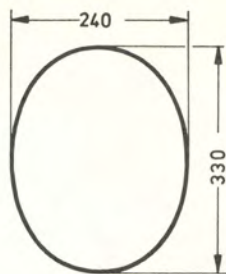

E 330x240.1
Konkav

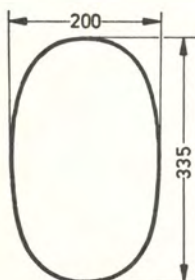

EZ 335 200-5.1
Konkav

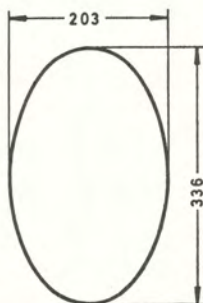

E 336 x 203 . 1
Konkav

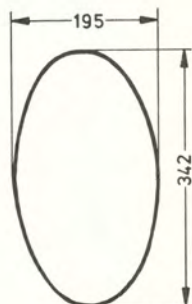

E 342x195.1
Konkav

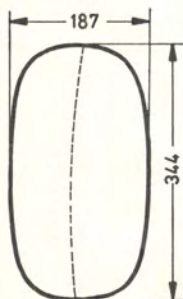

EZ 344x187.1
Konkav

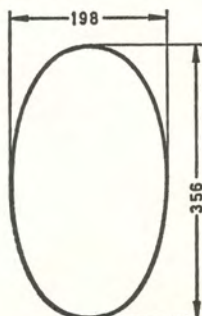

E 356 x 198 . 1
Konkav

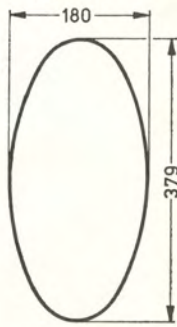

E379x180.1
Konkav

Elliptical shape
Forme elliptique
Elíptico
Ellipsform

Ellipsenform



E

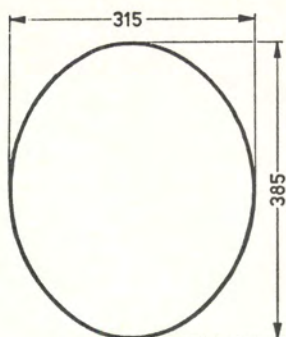

E385x315.1
Standard

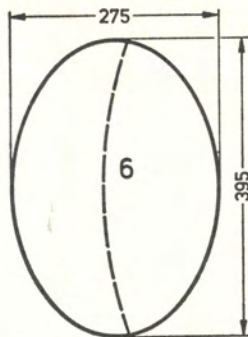

EZ 395 x 275.1
Konkav

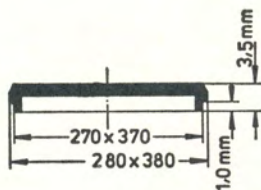

NE 380 x 280
370 x 270

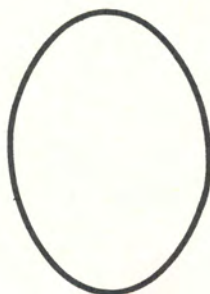

STERNKREUZ



Supplement

D Series

Dreieckform

Triangular shape

Forme triangulaire

Forma triangular

Trekantform



D



Dreieckform

Triangular shape
Forme triangulaire
Forma triangular
Trekantform

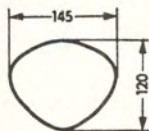

D 120 x 145 . 1
Konkav

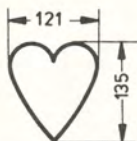

D 135 x 121.1
Konkav

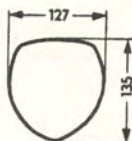

D 135 x 127 . 1
Konkav

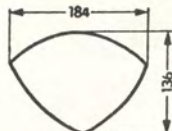

Dy 136 x 184 . 1
Konkav

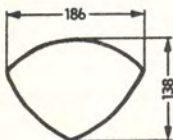

Dy 138 x 186 . 9
Konkav

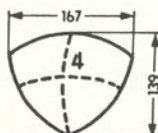

DX 139 x 167 . 1
Konkav

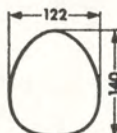

D 140 x 122.1
Konkav

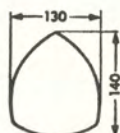

D 140 x 130.1
Konkav

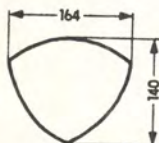

D 140 x 164 . 1
Konkav

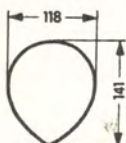

D 141 x 118 . 1
Konkav

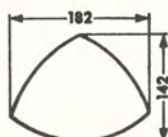

D 142 x 182.1
Konkav

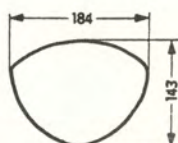

D 143 x 184 . 1
Konkav

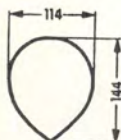

D 144 x 114 . 1
Konkav

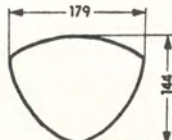

D 144 x 179 . 1
Konkav

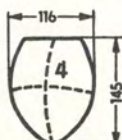

DX 145 x 116 . 1
Konkav

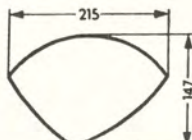

Dy 147 x 215 . 1
Konkav

Triangular shape
 Forme triangulaire
 Forma triangolare
 Trekantform

Dreieckform

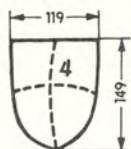

DX 149 x 119 . 1
 Konkav

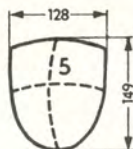

DX 149 x 128 . 1
 Konkav

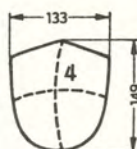

DX 149 x 133 . 1
 Konkav

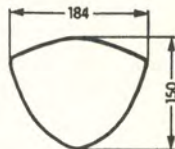

D 150 x 184 . 9
 Konkav

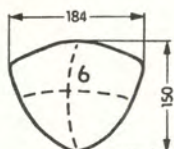

DX 150 x 184 . 1
 Konkav

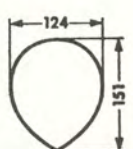

D 151 x 124 . 1
 Konkav

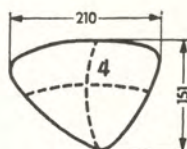

DXy 151 x 210 . 1
 Konkav

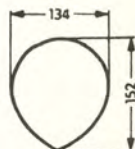

D 152 x 134 . 1
 Konkav

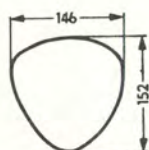

D 152 x 146 . 1
 Konkav

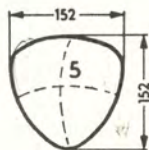

DX 152 x 152 . 1
 Konkav

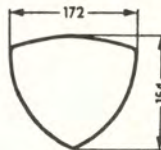

D 154 x 172 . 9
 Konkav

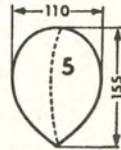

DZ 155 x 110 . 1
 Konkav

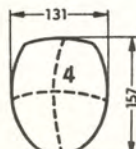

DX 157 x 131 . 1
 Konkav

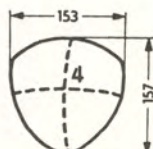

DX 157 x 153 . 1
 Konkav

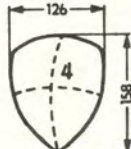

DX 158 x 126 . 1
 Konkav

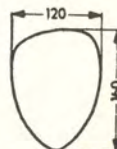

Dy 160 x 120 . 1
 Konkav



STERNKREUZ



Dreieckform

Triangular shape
 Forme triangulaire
 Forma triangular
 Trekantform

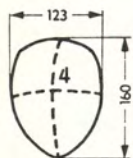

DX 160 x 123 . 1
 Konkav

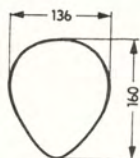

D 160 x 136 . 1
 Konkav

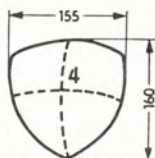

DX 160 x 155 . 1
 Konkav

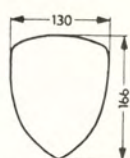

D 166 x 130 . 1
 Konkav

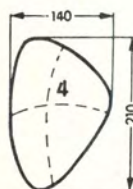

DXy 210 x 140 . 1
 Konkav

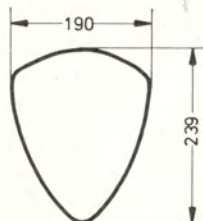

D 239 x 190.1
 Konkav

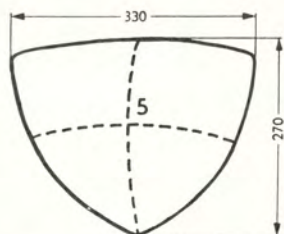

DX 270 x 330 . 1
 Konkav

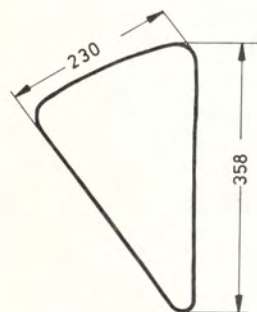

DY 358 x 230.1
 Konkav

Dreieckform • Triangular shape
Forme triangulaire • Forma triangular

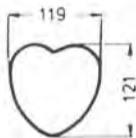

D 121 × 119,1
Konkav

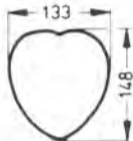

D 148 × 133,1
Konkav

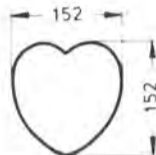

D 152 × 152,1
Konkav



Supplement

H Series

Hufeisenform

Horseshoe shape

Forme Fer à cheval

Forma Herradura

Hästskoform

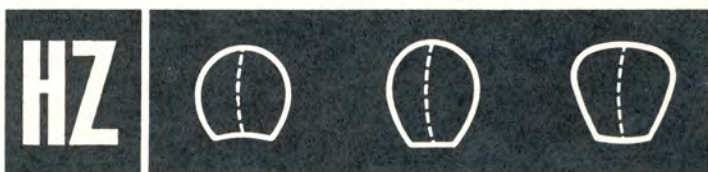

H



Hufeisenform

Horseshoe shape
Forme Fer à cheval
Forma Herradura
Hästskoform

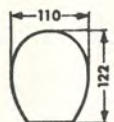

H 122 x 110.1
Konkav

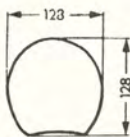

H 128 x 128.1
Konkav

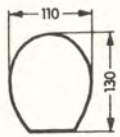

H 130 x 110.1
Konkav

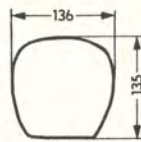

H 135 x 136.1
Konkav

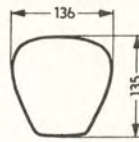

H 135 x 136.2
Konkav

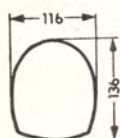

H 136 x 116.1
Konkav

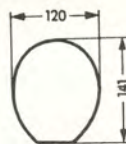

H 141 x 120.1
Konkav

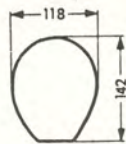

H 142 x 118.1
Konkav

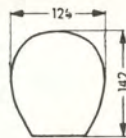

H 142 x 126.1
Konkav

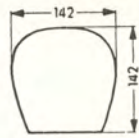

H 142 x 142.1
Konkav

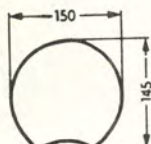

H 145 x 150.1
Konkav

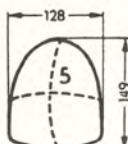

DX 149 x 128.1
Konkav

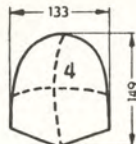

DX 149 x 133.1
Konkav

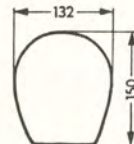

H 150 x 132.1
Konkav

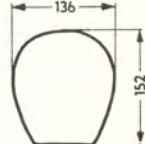

H 152 x 136.1
Konkav

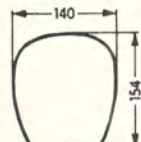

H 154 x 140.1
Konkav

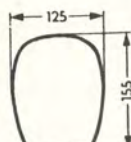

H 155 x 125.1
Konkav

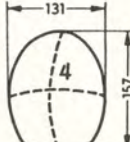

HX 157 x 131.1
Konkav

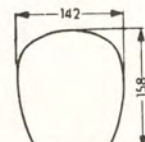

H 158 x 142.1
Konkav

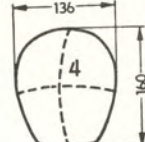

HX 160 x 136.1
Konkav

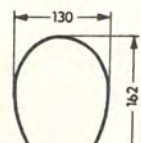

H 162 x 130.1
Konkav

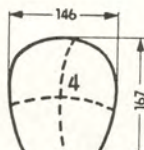

HX 167 x 146.1
Konkav

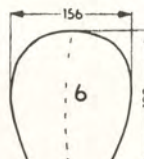

HZ 182 x 156.1
Konkav

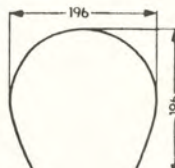

H 196 x 196.1
Konkav



Supplement

G Series

Geigenform

Violin shape

Forme à violon

Forma de violin

Fiolform

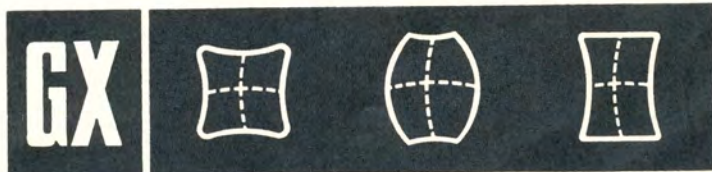

G

G

Geigenform

Violin shape
Forme à violon
Forma de violin
Fiolform

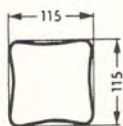

G 115 x 115 . 1
Konkav

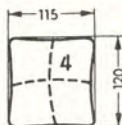

GX 120 x 115 . 1
Konkav

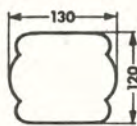

G 120 x 130.1
Konkav

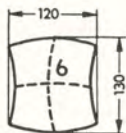

GX 130 x 120 . 1
Konkav

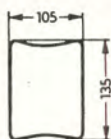

G 135 x 105 . 1
Konkav

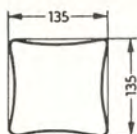

G 135 x 135 . 1
Konkav

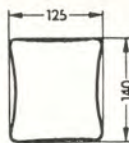

G 140 x 125 . 1
Konkav

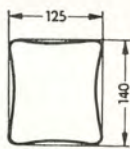

G 140 x 125 . 2
Konkav

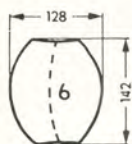

GZ 142 x 128 . 1
Konkav

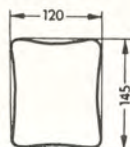

G 145 x 120 . 1
Konkav

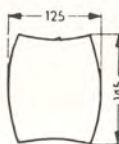

G 145 x 125 . 1
Konkav

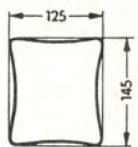

G 145 x 125 . 2
Konkav

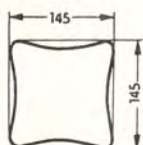

G 145 x 145 . 1
Konkav

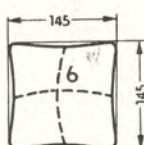

GX 145 x 145 . 1
Konkav

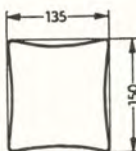

G 150 x 135 . 1
Standard
Konkav

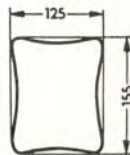

G 155 x 125 . 1
Konkav

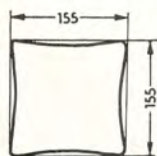

G 155 x 155 . 1
Konkav

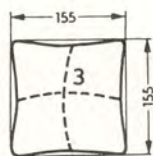

GX 155 x 155 . 1
Konkav

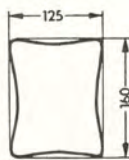

G 160 x 125 . 1
Konkav

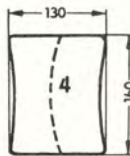

GZ 160 x 130 . 1
Standard
Konkav

Violin shape
Forme à violon
Forma de violin
Fiolform

Geigenform



G

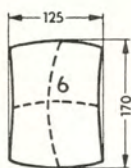

GX 170 x 125 . 1
Standard
Konkav

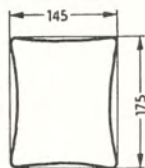

G 175 x 145 . 1
Standard
Konkav

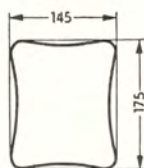

G 175 x 145 . 2
Konkav

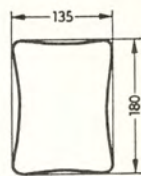

G 180 x 135 . 1
Konkav

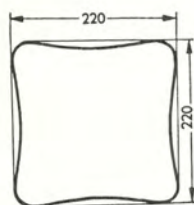

G 220 x 220 . 1
Konkav

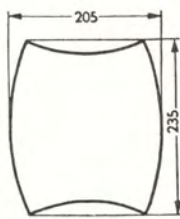

G 235 x 205 . 1
Konkav



STERNKREUZ

Spezialformgläser

Special shaped glasses

Verres spéciaux façonnés

cristales especiales modelados

Special formglas

Spezial

1. Unterleggläser

Underlayered-glasses
Verres d'assise
cristales de forma de asiento
Underläggs-formglas

2. Kapsel-formgläser

Capsules
Capsules
Capsules
Kapslar

3. Nutgläser

Grooved glasses
Verre avec facette rainurée
cristales con ranura
Ansatzglas

4. Plan Formgläser

flat glasses
Verres plats
cristales planos
plan formglas

5. LED Formgläser

LED Fancy-glasses
Verres LED
cristales LED
LED formglas

1. Unterleggläser

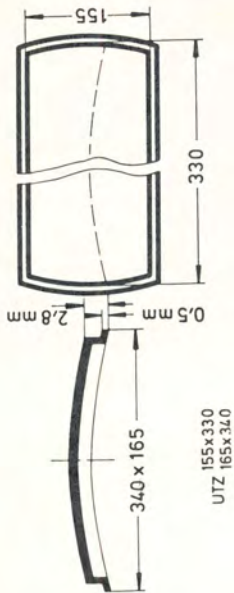

UTZ 155x330
165x340

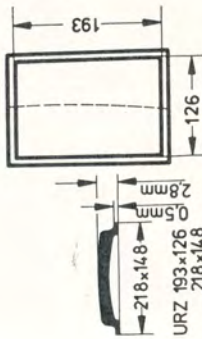

URZ 193x126
218x148

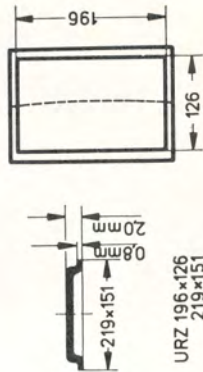

URZ 196x126
219x151

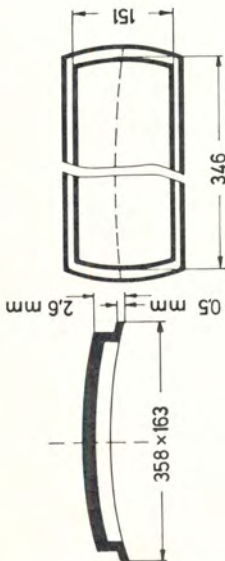

UTZ 151x346
163x358

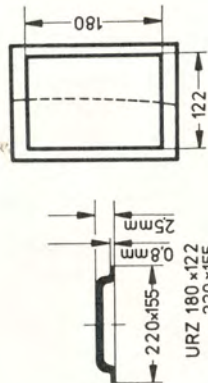

URZ 180x122
220x155

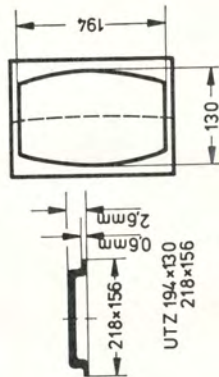

UTZ 194x130
218x156

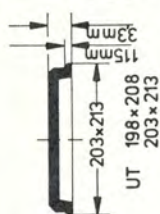
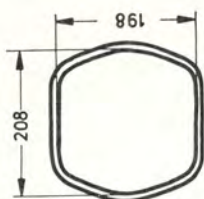

UT 198 x 208
203 x 213

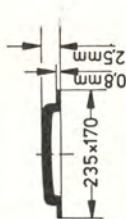
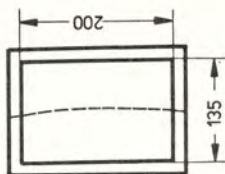

URZ 200 x 135
235 x 170

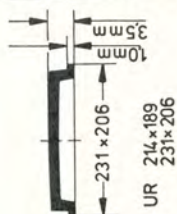
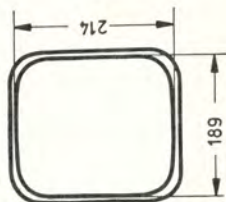

UR 214 x 189
231 x 206

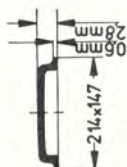
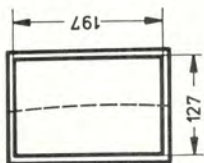

URZ 197 x 127
214 x 147

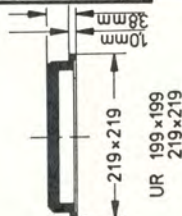
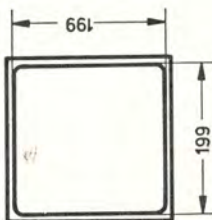

UR 199 x 199
219 x 219

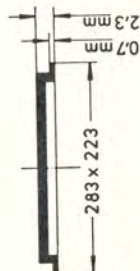
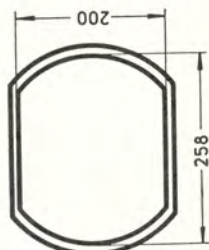

UT 200 x 258
223 x 283

* URZ 197 147



STERNKREUZ

Unterleggläser

Underlayered-glasses
Verres d'assise
cristales de forma de asiento
Underläggs-formglas

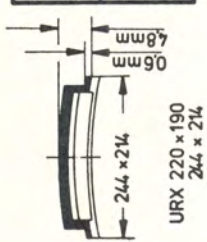
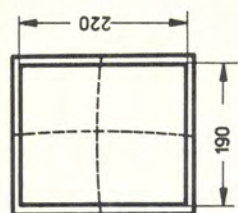

URX 220 x 190
244 x 214

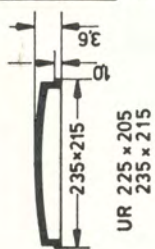
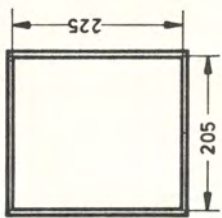

UR 225 x 205
235 x 215

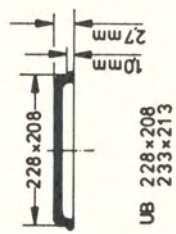
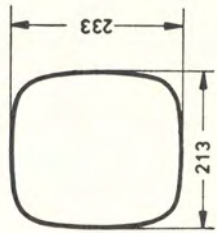

UB 228 x 208
233 x 213

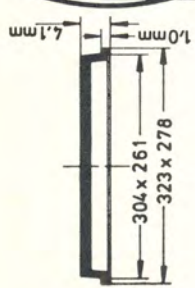
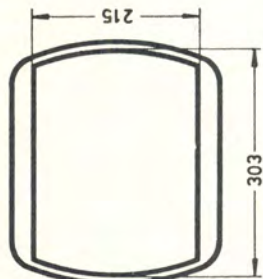

UT 215 x 303
278 x 323

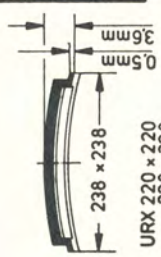
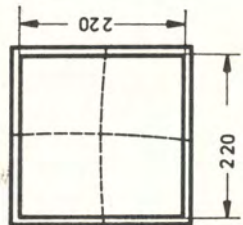

URX 220 x 220
238 x 238

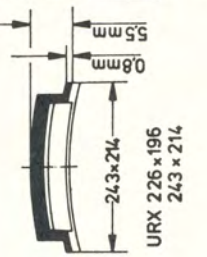
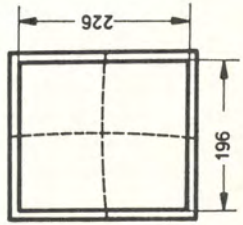

URX 226 x 196
243 x 214



URX 220 238

Underlayered-glasses
 Verres d'assise
 cristales de forma de asiento
 Underläggs-formglas

Unterleggläser

UBT
 230328

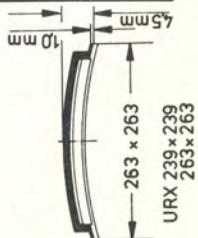
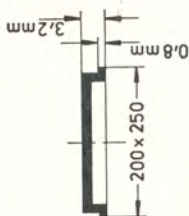
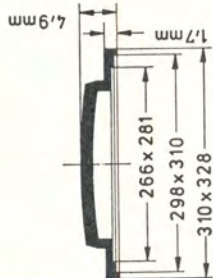
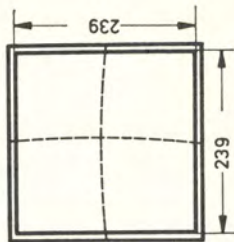
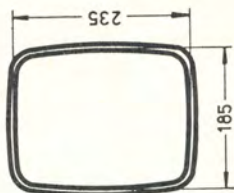
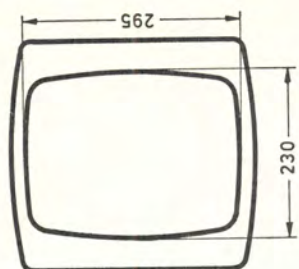

UBT
 230 x 295
 310 x 328

UB
 235 x 185
 250 x 200

URX
 239 x 239
 263 x 263

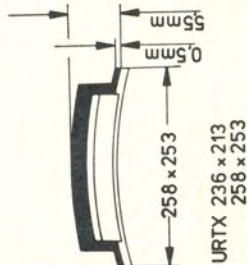
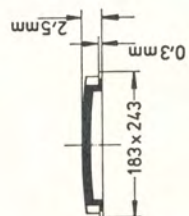
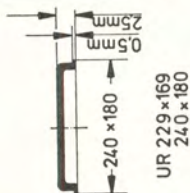
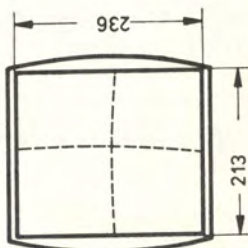
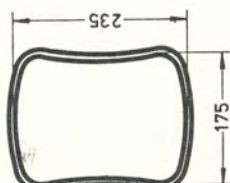
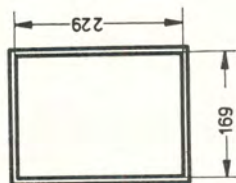

UR
 229 x 169
 240 x 180

UG
 235 x 175
 243 x 183

URTX
 236 x 213
 258 x 253



STERNKREUZ

Unterleggläser

Underlayered-glasses
Verres d'assise
cristales de forma de asiento
Underläggs-formglas

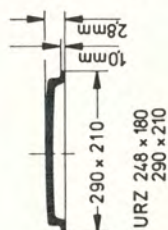
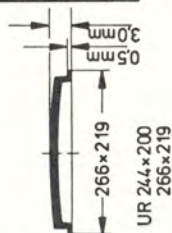
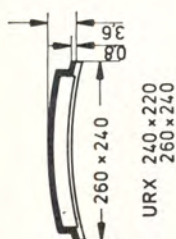
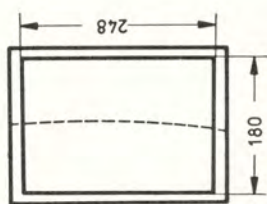
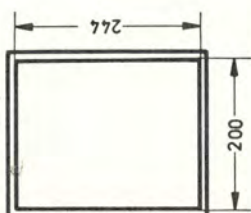
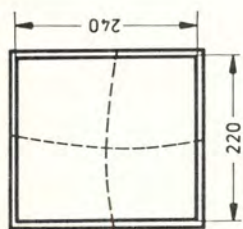
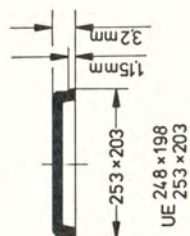
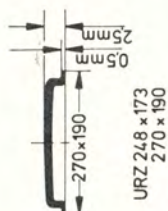
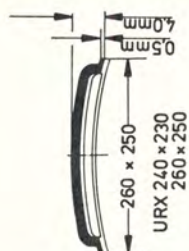
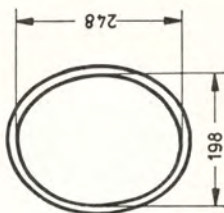
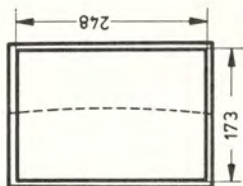
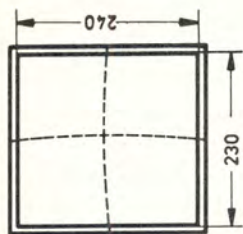

UR 244 x 200

•

Underlayered-glasses
 Verres d'assise
 cristales de forma de asiento
 Underläggs-formglas

Unterleggläser



URX 250x260

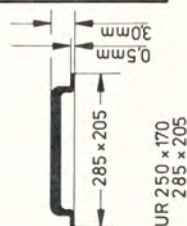
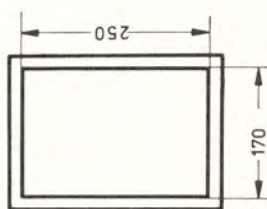
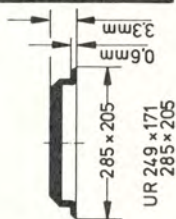
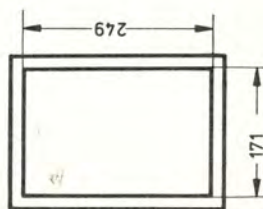
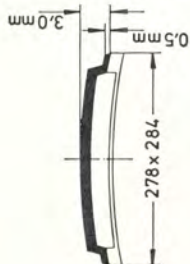
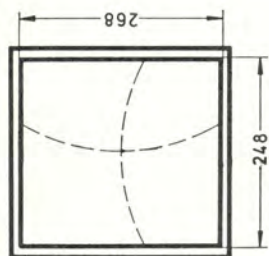
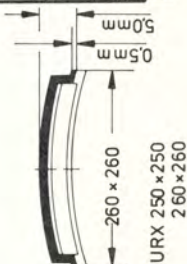
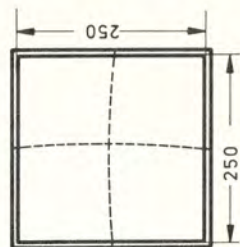
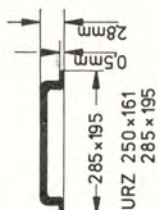
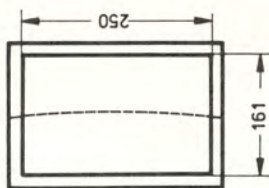
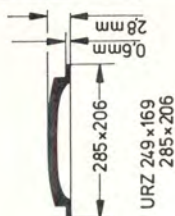
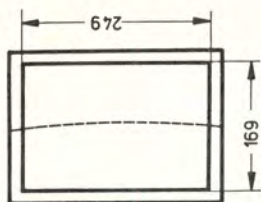

STERNKREUZ

Unterleggläser

Underlayered-glasses
Verres d'assise
cristales de forma de asiento
Underläggs-formglas

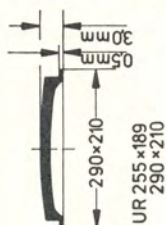
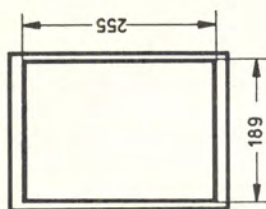

UR 255 x 189
290 x 210

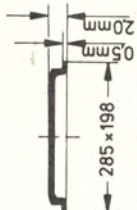
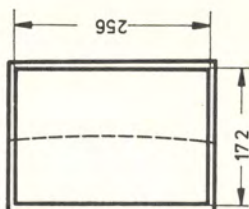

URZ 256 x 172
285 x 198

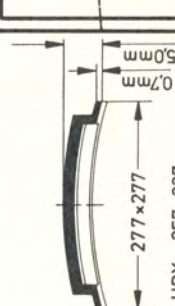
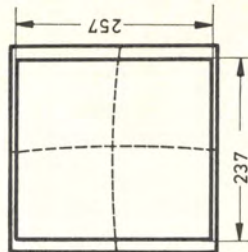

URX 257 x 237
277 x 277

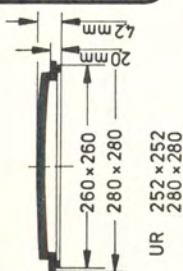
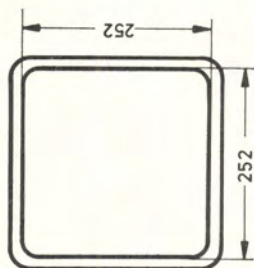

UR 252 x 252
280 x 280

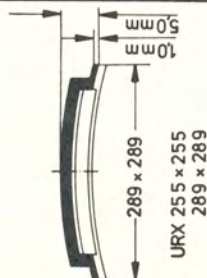
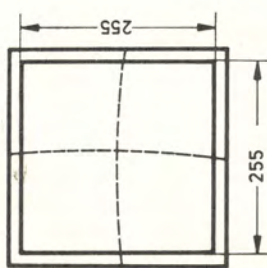

URX 255 x 255
289 x 289

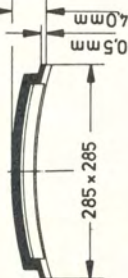
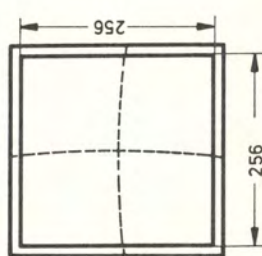

URX 256 x 256
285 x 285

Underlayered-glasses
Verres d'assise
cristales de forma de asiento
Underläggs-formglas

UR 2260 208
*

Unterleggläser

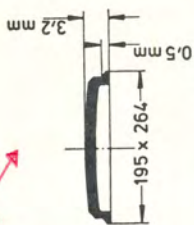
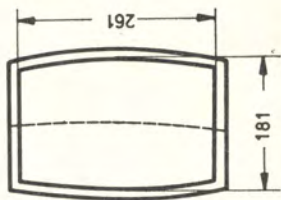
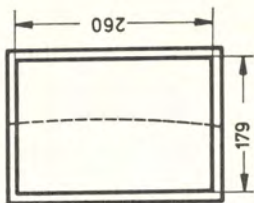
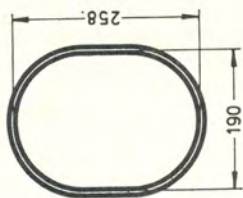

UE 258 x 190
UE 264 x 195

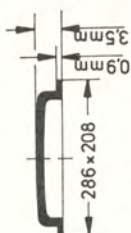

URZ 260 x 179
URZ 286 x 208

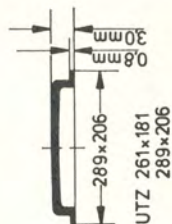

UTZ 261 x 181
UTZ 289 x 206

UE 258 195

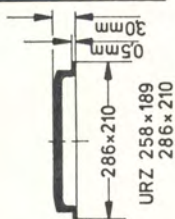
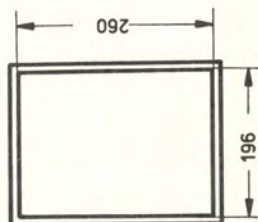
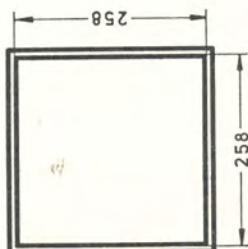
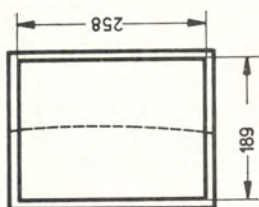

URZ 258 x 189
URZ 286 x 210

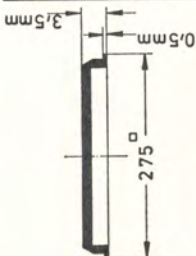

UR 258 x 258 Seiko
UR 275 x 275

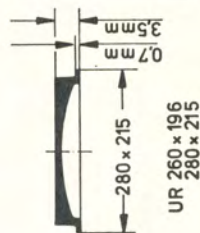

UR 260 x 196
UR 280 x 215



STERNKREUZ

URX263280

*

Unterleggläser

UR264277

Underlayered-glasses
Verres d'assise
cristales de forma de asiento
Underläggs-formglas

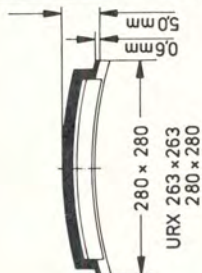
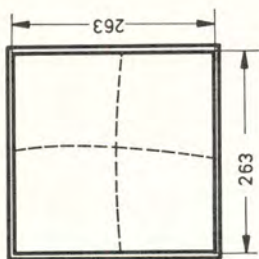

URX 263 x 263
280 x 280

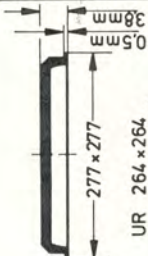
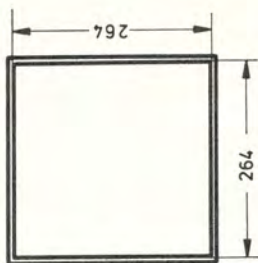

UR 264 x 264
277 x 277.2

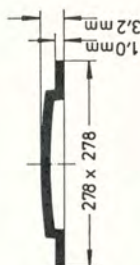
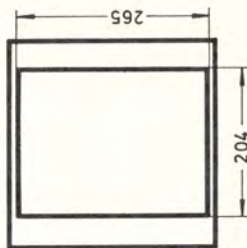

UR 265 x 204
278 x 278

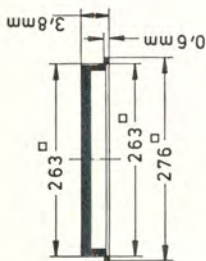
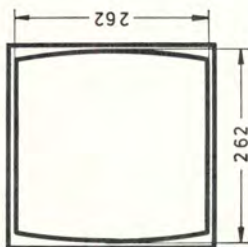

UTR 263 x 263
276 x 276

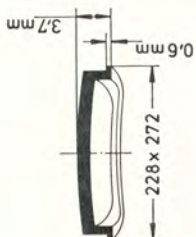
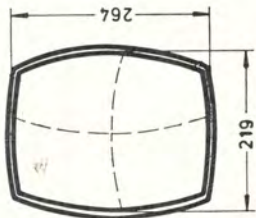

UBX 264 x 219
272 x 228

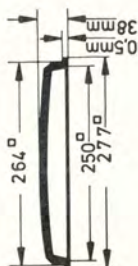
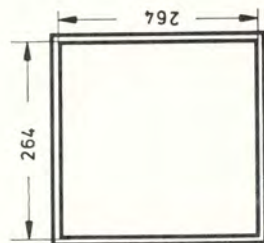

UR 264 x 264
277 x 277.1

UTR 263276

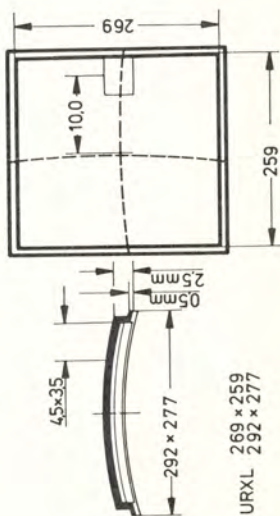
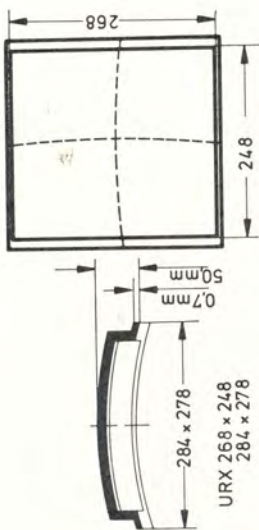
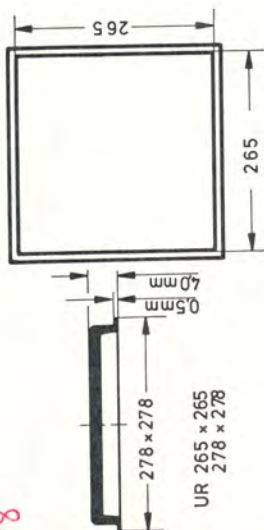
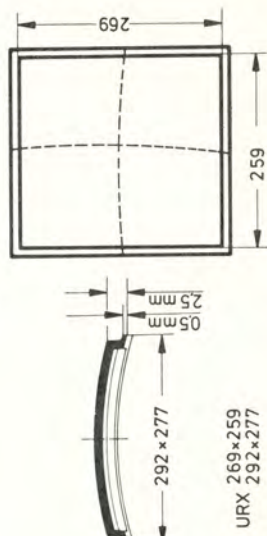
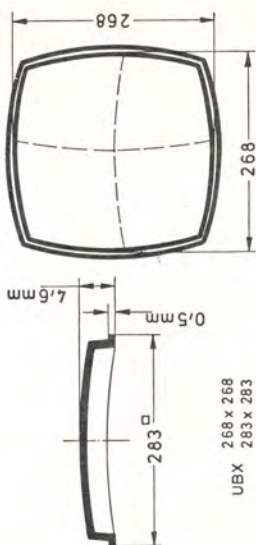
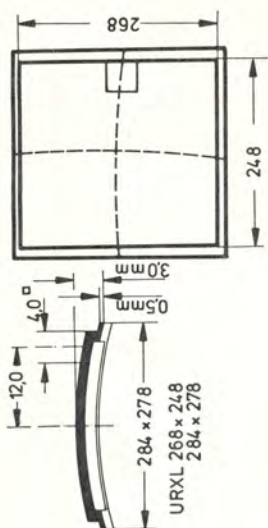

UR 265 278
 ↑

Unterleggläser

Underlayer-glasses
Verres d'assise
cristales de forma de asiento
Underläggs-formglas

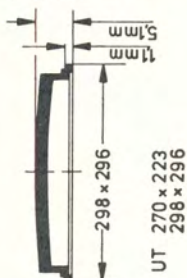
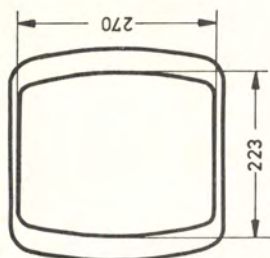

UT 270 x 233
298 x 296

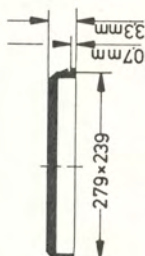
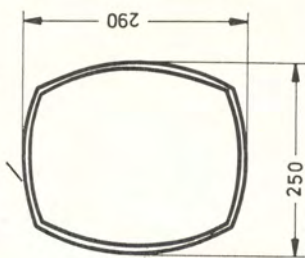

UB 279 x 239
290 x 250

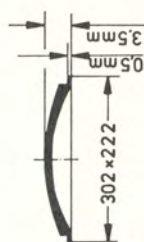
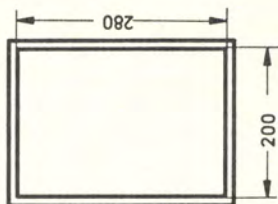

UR 280 x 200
302 x 222

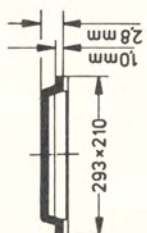
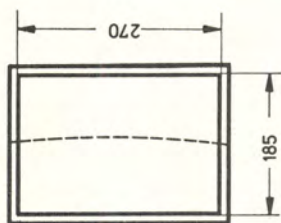

URZ 270 x 185
293 x 210

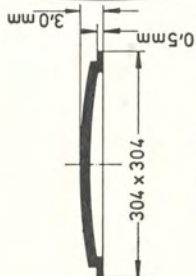
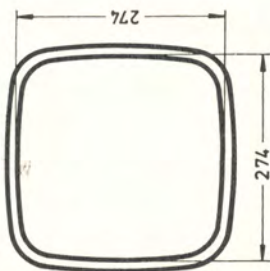

UB 274 x 274
304 x 304

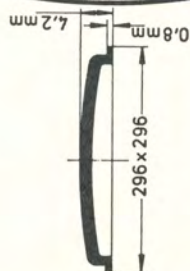
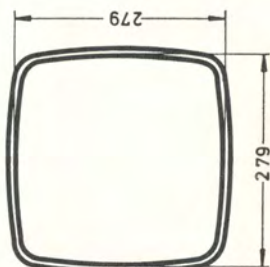

UB 279 x 279
296 x 296

Underlayered-glasses
 Verres d'assise
 cristales de forma de asiento
 Underläggs-formglas

Unterleggläser

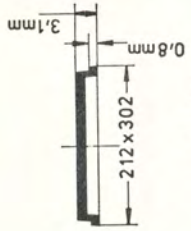
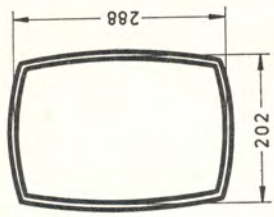

UB 288x202
302x212

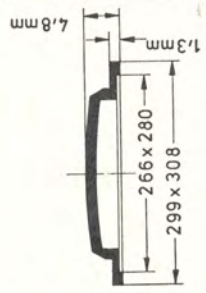
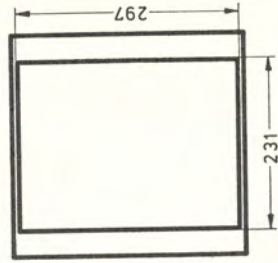

UR 297x231 Seiko
308x299

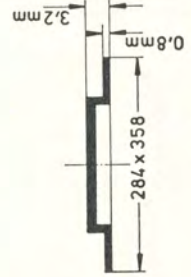
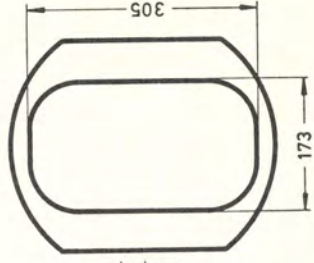

URT 305x173
358x284

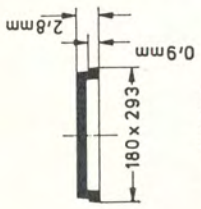
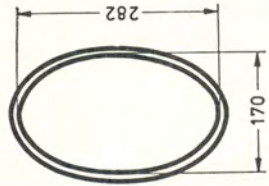

UE 282x170
293x180

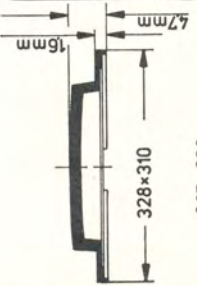
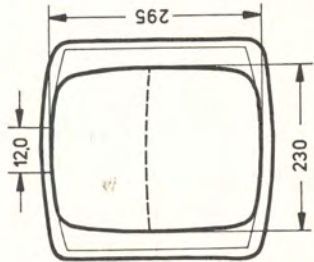

UBT 295x230
328x310

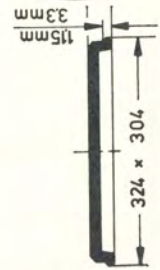
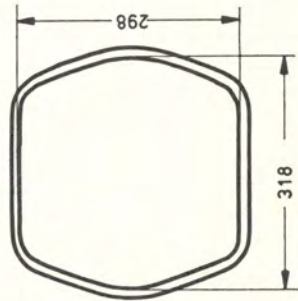

UT 298x318
304x324



STERNKREUZ

Unterleggläser

Underlayered glasses
Verres d'assise
cristales de forma de asiento
Underläggs-formglas

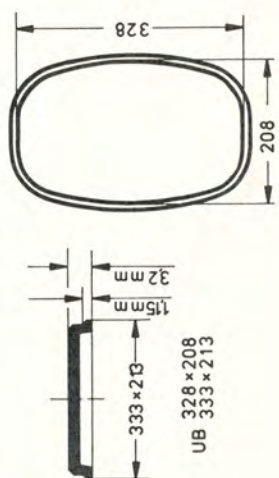
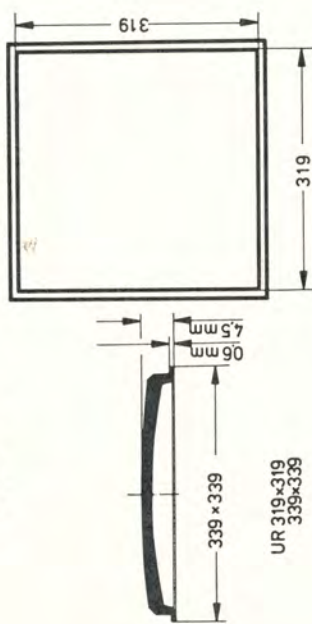
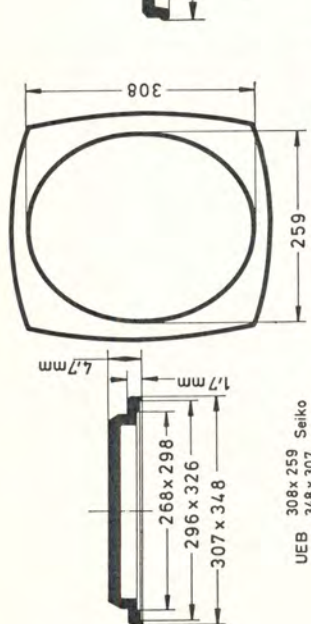
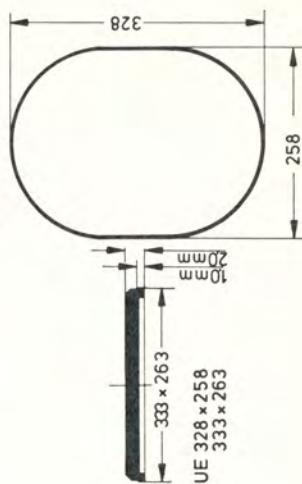
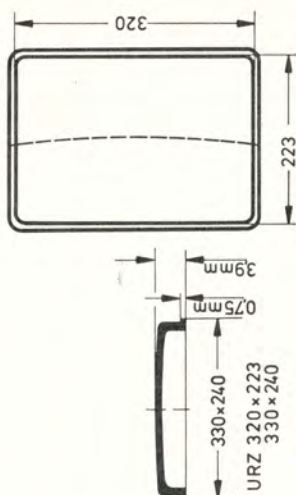
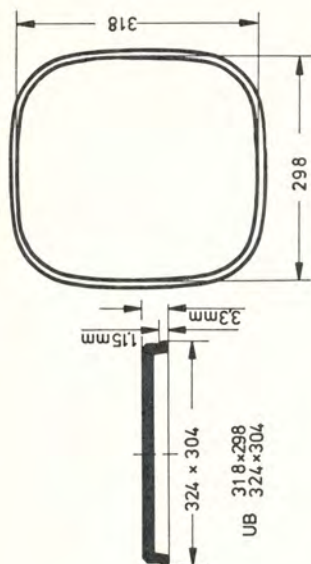

Underlayered-glasses
 Verres d'assise
 cristales de forma de asiento
 Underläggs-formglas

Unterleggläser

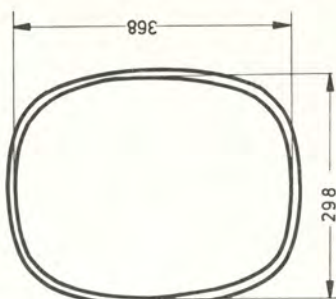
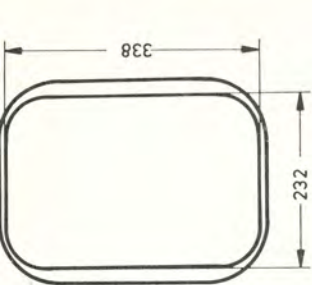

oval FRANGED.
FAIRE LOUDA
 24.80 x 2980
 BASE = 27 x 31 φ

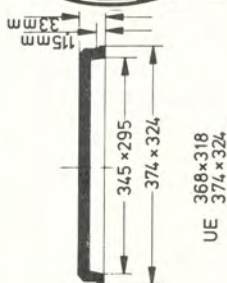
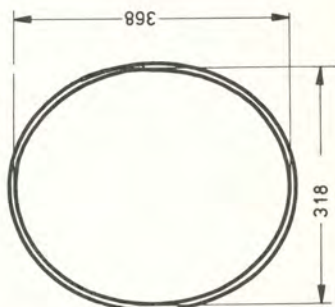
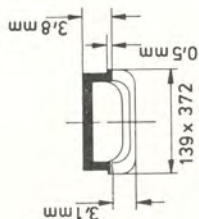
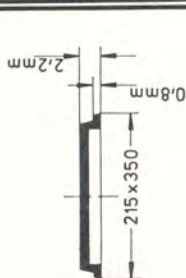
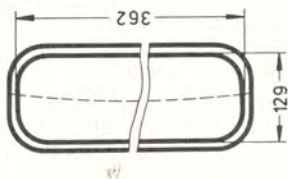
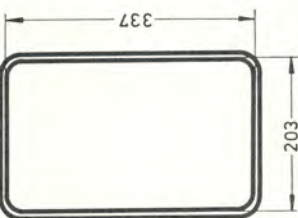
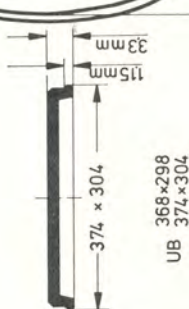
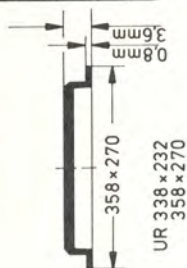

STERNKREUZ

Capsules
Capsules
Capsules
Kapslar

2. Kapsel-formgläser

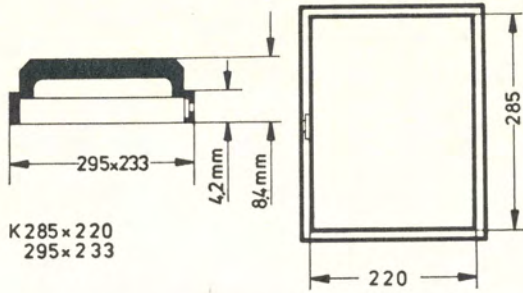

K 285 x 220
295 x 233

Grooved glasses
Verre avec facette rainurée
cristales con ranura
Ansatzglas

3. Nutgläser

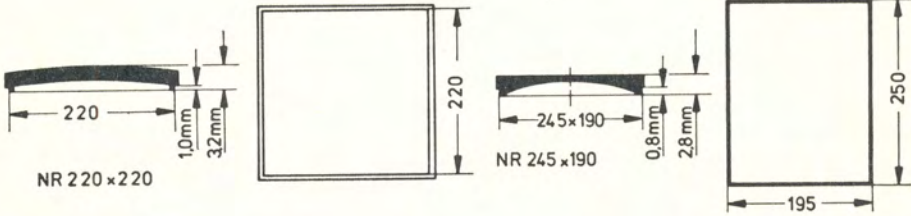

NR 220 x 220

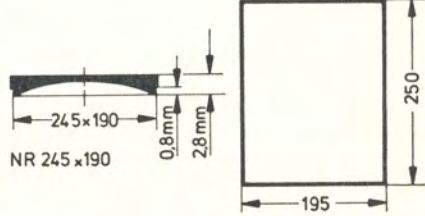

NR 245 x 190

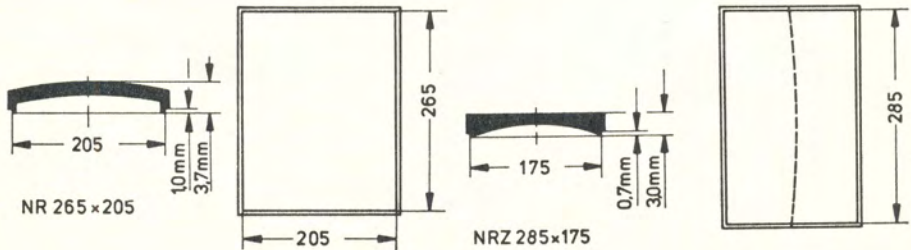

NR 265 x 205

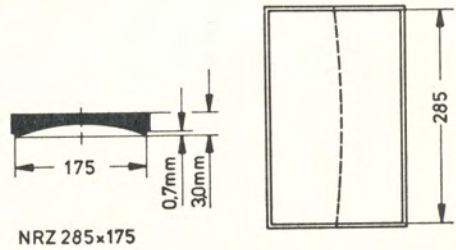

NRZ 285 x 175

4. Plan-formgläser

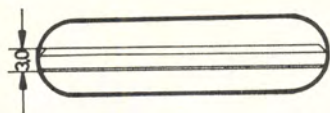

PI.T 104×392×300

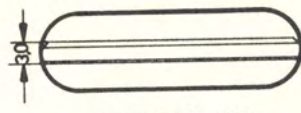

PI T 105×355×260

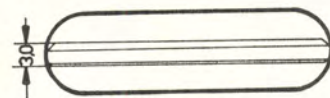

PI T 109×384×290

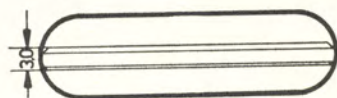

PI.T 117 × 396 × 290

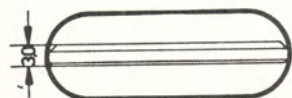

PI T 120×329×210

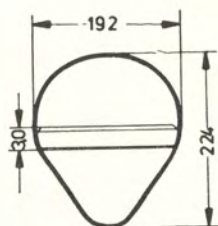

PI.D 224 × 192

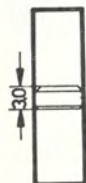

PI.R 239 × 75

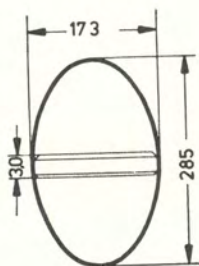

PI.E 285×173

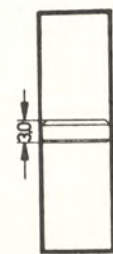

PI R 327×100

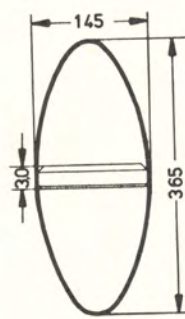

PI.E 365×145

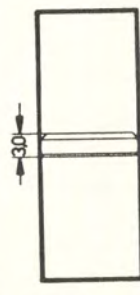

PI.R 367×132

5. LED Formgläser

LED Fancy-glasses
Verres LED
cristales LED
LED formglas

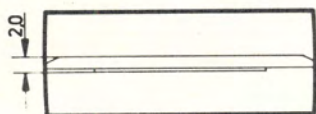

LED T 142x366

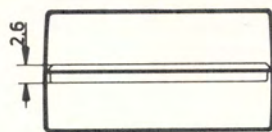

LED T 168x313

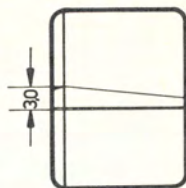

LED R 239x179

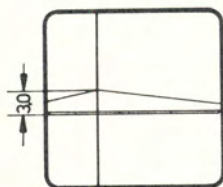

LED R 239x239

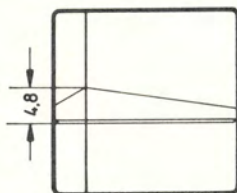

LED R 249x249

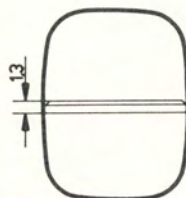

LED B 260x197